

STR-D2070X/D3070X

SERVICE MANUAL

US Model
Canadian Model
STR-D2070X/D3070X:
E Model
STR-D2070X:

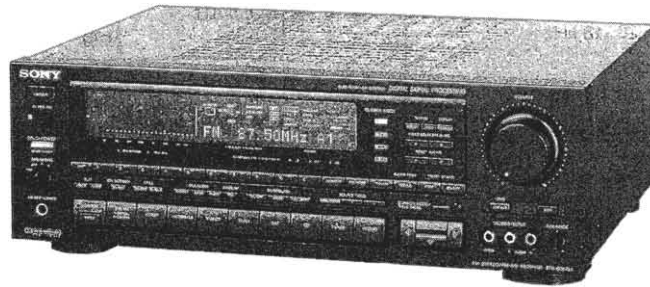

Photo: STR-D3070X

SPECIFICATIONS

Audio Power Specifications

POWER OUTPUT AND TOTAL HARMONIC DISTORTION

With 8-ohm load, both channels driven, from 20 - 20,000 Hz, rated 120 watts per channel minimum RMS power, with no more than 0.015% total harmonic distortion from 250 milliwatts to rated output.

Other Specifications

Dynamic power output	8 ohms, at 1 kHz IHF	195 + 195 watts
	4 ohms, at 1 kHz IHF	250 + 250 watts
Harmonic distortion at rated output		Less than 0.015%
Intermodulation (IM) distortion at rated output		Less than 0.015%
Power output of center amplifier		30 watts (15 + 15 watts, 8 ohms at 1kHz)
Power output of surround(REAR)/DRLC amplifier (8 ohms, at 1kHz)		15 + 15 watts
Frequency response	PHONO	RIAA equalization curve ± 0.5 dB
	CD, DAT, TAPE 1,2 DIGITAL (OPTICAL, COAXIAL) VIDEO 1,2,3	10 Hz — 70 kHz ± 1 dB

Residual noise		Less than 70 μ V
Damping factor (8 ohms, at 1kHz)		50
Input sensitivity/impedance	PHONO MM	2.5 mV, 50 kilohms
	DAT,CD, VIDEO 1,2,3 TAPE 1,2	150 mV 50 kilohms
	DIGITAL (COAXIAL)	0.5 Vp-p, ± 20 %,75 ohms
	DIGITAL (OPTICAL)	TOSLINK
S/N	PHONO MM	87 dB 79 dB** (A,2.5mV)
	DAT, CD VIDEO 1,2,3 TAPE 1,3	105 dB 85 dB** (A,150mV)

Output sensitivity/impedance	DAT OUT, TAPE OUT 1,2 VIDEO 1	150 mV 10 kilohms
	SPEAKERS	Accepts speakers of 8-16 ohms
	HEADPHONES	Accepts headphones of high and low impedance
	CENTER OUT, REAR OUT	2.5 V, 1kilohm
	PRE OUT	1 V, 1Kilohm
MUTING		-20dB

** '78IHF

— Continued on page 2 —

FM STEREO / FM-AM RECEIVER
SONY®



Digital signal processor section

Modulation (A/D conversion)		High Density Linear Converter
Demonstration (D/A conversion)		High Density Linear Converter System (Pulse D/A Converter)
Sampling frequency		32 kHz, 44.1 kHz, 48 kHz
Equalizer	Band	3-band, Bass/treble Mid
	Turnover frequency	Bass: 99 Hz - 1 kHz Treble: 1 kHz - 10 kHz
	center frequency	Mid: 20 -18 kHz
	Level	±12 dB, 0.2 dB step
	Slope (Q)	3-step selectable, Wide, Mid, Narrow
DDS	compressor expander	9-step adjustable 9-step adjustable
Surround	ROOM SIZE	20-step adjustable
	WALL	20-step adjustable
	SEAT POSITION F/R	20-step adjustable
	SEAT POSITION L/R	20-step adjustable
	EFFECT LEVEL	20-step adjustable
	REVERB TIME	20-step adjustable
	DELAY TIME	15.0 ms-30. ms, 0.1 ms step
	REAR LEVEL	+10 --50 dB, --∞, 1 dB step
	CENTER LEVEL	+10 --50 dB, --∞, 1 dB step
	INPUT BALANCE	Automatic

FM tuner section

Frequency range		87.5 — 108.0 MHz
Antenna terminals		300 ohms, balanced 75 ohms, unbalanced
Sensitivity at 50 dB		18.3 dBf, 4.5 μV (mono) 38.3 dBf, 45 μV (stereo)
Usable sensitivity		11.2 dBf, 2 μV (IHF)
S/N	Mono	80 dB
	Stereo	74 dB
Harmonic distortion at 1 kHz	Mono	0.3 %
	Stereo	0.5 %
IM distortion	Mono	0.3 %
	Stereo	0.5 %
Separation		45 dB at 1 kHz
Frequency response		30 Hz — 15 kHz $^{+0}_{-2}$ dB
Selectivity		60 dB at 400 kHz
Capture ratio		1.2 dB
AM suppression ratio		54 dB

Image response ratio		70 dB
IF response ratio		70 dB
Spurious response ratio		80 dB
RF intermodulation at 800 kHz		60 dB
Auto tuning threshold	Low	30 dBf
	High	50 dBf

AM-tuner section

Frequency range	530 — 1710 kHz (with 10 kHz interval) 531 — 1710 kHz (with 9 kHz interval)
Antenna	Loop antenna
Usable sensitivity	50 dB/m (at 1,000 kHz or 999 kHz)
S/N	54 dB (at 50 mV/m)
Harmonic distortion	0.5% (50 mV/m, 400 Hz)
Selectivity	35 dB (9 kHz), 40 dB (10 kHz)
Auto tuning threshold	55 dB/m

Video section

Inputs	VIDEO 1,2,3: 1 Vp-p 75 ohms
Outputs	VIDEO 1, MONITOR: 1 Vp-p 75 ohms

General

		STR-D3070X	STR-D2070X
System	Tuner section	PLL quartz-locked digital synthesizer system	
	Preamplifier section	Low-noise NF type equalizer	
	Power amplifier section	Pure-complimentary SEPP	
Power requirements		120 V AC, 60 Hz	
Power consumption		USA model: 260 watts Canada model: 550 VA E model: 120, 220 or 240 V adjustable	
AC outlets		Two switched, total 120 watts	
Dimensions		430 x 147.5 x 373 mm (17 x 5 ⁷ / ₈ x 14 ³ / ₄ inches)	
Weight		14.5 kg (32 lb)	13.5 kg (29 lb 13 oz)



Supplied accessories FM ribbon antenna (1)
External antenna connector (1)
AM loop antenna (1)
Remote commander RM-P311 (†)
External antenna connector (1)
Sony Batteries SUM-3(NS) (2)

Design and specifications are subject to change without notice.

TABLE OF CONTENT

<u>Section</u>	<u>Title</u>	<u>Page</u>	<u>Section</u>	<u>Title</u>	<u>Page</u>
	Specification	1	4. EXPLODED VIEWS		
1. GENERAL			4-1. Front Panel Section		59
	Overview	4	4-2. Chassis Section (1)		60
	Precautions	4	4-3. Chassis Section (2)		61
	Hooking Up the System	5	5. ELECTRICAL PARTS LIST		62
	Parts Identification	7			
2. ELECTRICAL ADJUSTMENT		9			
3. DIAGRAMS					
	3-1. Circuit Boards Location	13			
	3-2. Semiconductor Lead Layouts	14			
	3-3. Block Diagrams	15			
	3-4. Printed Wiring Boards (1)	20			
	3-5. Schematic Diagrams (1)	25			
	3-6. Schematic Diagrams (2)	31			
	3-7. Schematic Diagrams (3)	35			
	3-8. Printed Wiring Boards (2)	39			
	3-9. Schematic Diagrams (4)	43			
	3-10. Schematic Diagrams (5)	49			

SAFETY-RELATED COMPONENT WARNING!!

COMPONENTS IDENTIFIED BY MARK  OR DOTTED LINE WITH MARK  ON THE SCHEMATIC DIAGRAMS AND IN THE PARTS LIST ARE CRITICAL TO SAFE OPERATION. REPLACE THESE COMPONENTS WITH SONY PARTS WHOSE PART NUMBERS APPEAR AS SHOWN IN THIS MANUAL OR IN SUPPLEMENTS PUBLISHED BY SONY.

ATTENTION AU COMPOSANT AYANT RAPPORT À LA SÉCURITÉ!

LES COMPOSANTS IDENTIFIÉS PAR UNE MARQUE  SUR LES DIAGRAMMES SCHÉMATIQUES ET LA LISTE DES PIÈCES SONT CRITIQUES POUR LA SÉCURITÉ DE FONCTIONNEMENT. NE REMPLACER CES COMPOSANTS QUE PAR DES PIÈCES SONY DONT LES NUMÉROS SONT DONNÉS DANS CE MANUEL OU DANS LES SUPPLÉMENTS PUBLIÉS PAR SONY.

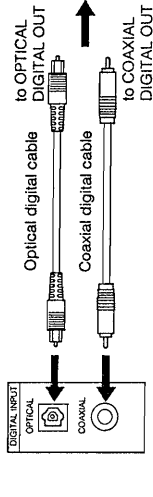
Connecting Audio Equipment**Connecting a CD player or DAT deck equipped with digital outputs****Caution**

Do not connect the DAT deck to the REC OUT jacks when it is connected to the DIGITAL INPUT jack. It makes a loop of audio signal and may cause malfunction.

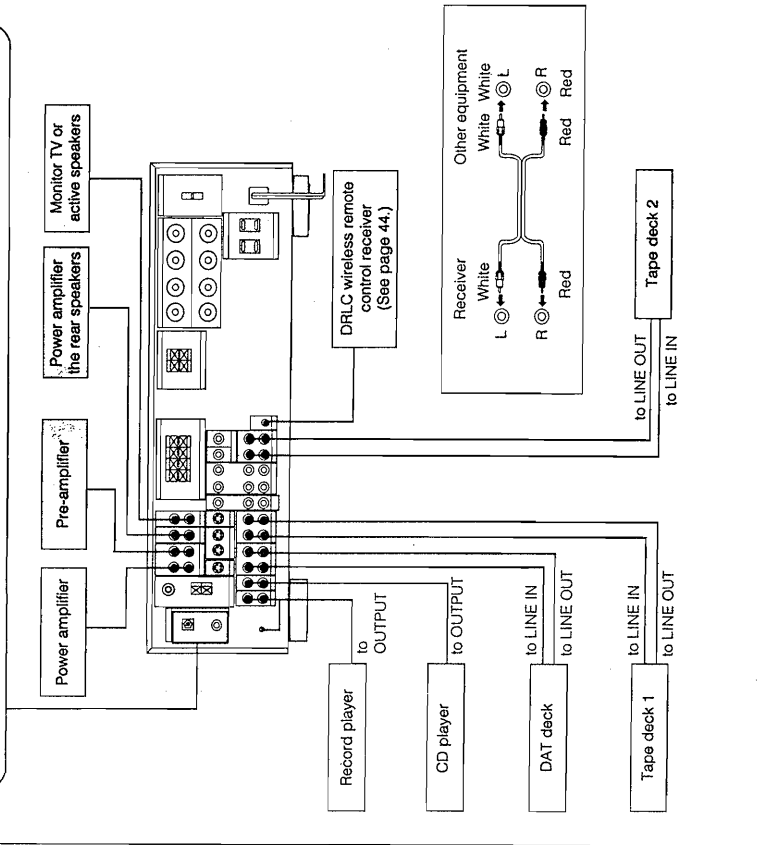
**Digital Dynamic Sound (DDS)**

- You can use the compressor or expander to control the dynamics:
 - the compressor compresses the dynamic range of the program source, so you can enjoy dynamic sound at small output levels.
 - the expander eliminates undesired noise.

Sound field

- 10 recommended sound field programs (combination of surround, parametric equalizer, and digital dynamic sound settings) are preset in the factory for easy use. You can also store up to 10 settings you created in the memory.
- Combined use of the sound field programs and the preset stations allow you to enjoy broadcast listening immediately with the memorized sound field settings.

ON SCREEN function (STR-D3070X only)

- This function allows you to monitor the operation being performed on the monitor TV.

TITLE function (STR-D3070X only)

- With this function, you can edit a title and superimpose it on your picture.

Dual room link control (DRLC)

- With the optionally available Dual Room Link control kit RM-2070K, you can obtain the DRLC function which links a second room to your main or primary listening room. You can enjoy listening to either the same program source being played in the main room or a different program source in the second room.

Programmable system commander RM-P311

- The supplied remote commander can "learn" the various functions of other remote commanders of the infrared type.

The STR-D3070X/D2070X is an FM Stereo/FM-AM receiver and audio/video control center.

You can enjoy various audio/video program sources with this unit.

TV/video programs

- You can enjoy TV or CATV programs with FM simulcast.
- Sounds from various audio program sources can be added on video tapes during editing.

Tuner

- Precise tuning is ensured by a quartz lock digital synthesizer.
- Station Index system allows you to tune into a station quickly.

Front panel

- The buttons and switches on the front panel are placed practically so that you can operate this receiver easily.

Digital surround processor

- The STR-D3070X/D2070X electronically reproduces the reflected sound (early reflection) and reverboration sound (reverberation) by using its digital signal processor, and allows you to obtain the acoustics of various situations.

- Dolby Surround™** decoder reproduces the specially encoded surround sound of Dolby surround video programs.

Manufactured under license from Dolby Laboratories Licensing Corporation, U.S. Patents 3,632,866, 3,746,792, and 3,850,590, Canadian Patents 1,004,803 and 1,037,877, "DOLBY" and the double-D symbol  are trademarks of Dolby Laboratories Licensing Corporation.

Digital parametric equalizer

- You can enjoy audio program sources with appropriate equalization curve by controlling the level of the desired 3 frequency bands.

Precautions**On safety**

- Operate the unit only on 120 V AC, 60 Hz.
- Should any solid object or liquid fall into the cabinet, unplug the unit and have it checked by qualified personnel before operating it any further.
- Unplug the unit from the wall outlet if it is not to be used for an extended period of time. To disconnect the cord, pull it out by grasping the plug. Never pull the cord itself.
- One blade of the plug is wider than the other for the purpose of safety and will fit into the power outlet only one way. If you are unable to insert the plug fully into the outlet, contact your dealer.

On operation

Before making program source connections, be sure to turn the power switch off and unplug the unit.

On cleaning the cabinet

Clean the cabinet, panel and controls with a soft cloth lightly moistened with mild detergent solution. Do not use any type of abrasive pad, scouring powder, or solvent such as alcohol or benzene.

For the customers in the U.S.A.

For detailed safety precautions, see the "IMPORTANT SAFEGUARDS" leaflet.

If you have any question or problem concerning your unit, please consult your nearest Sony dealer.

**Introduction
Overview**

Hooking Up the System

Connecting Video Equipment

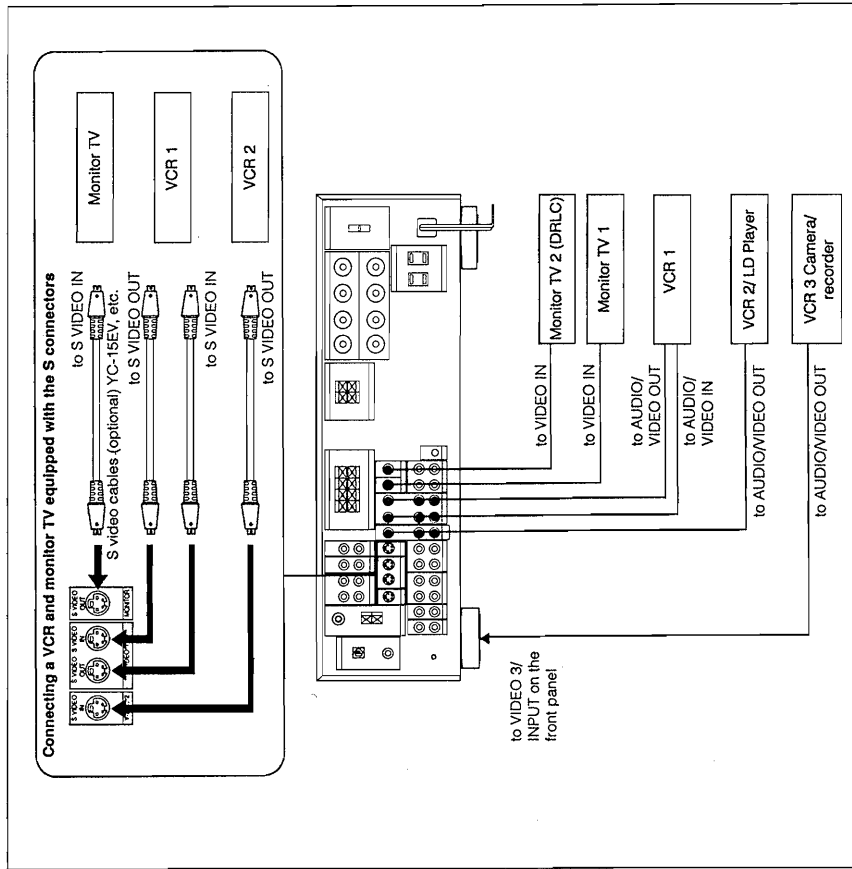

Notes

- The unit has independent input/output circuitries for the S VIDEO and VIDEO IN jacks. Therefore, the video signal input from VIDEO IN does not output for the S VIDEO OUT jacks, and vice versa.
- When the VIDEO 1 S VIDEO IN and VIDEO 2 S VIDEO IN/OUT jacks are connected, use the phono jacks of VIDEO 1 IN and VIDEO 2 IN/OUT for the audio signals.

Caution for STR-D3070X

When the MONITOR VIDEO OUT jack is connected and ON SCREEN ON/OFF is set to ON (The ON SCREEN indicator lights up.), the cursor mode operation buttons cannot be used for the other functions than the ON SCREEN function.

When the MONITOR S VIDEO OUT jack is connected, the ON SCREEN function cannot be available.

Connecting Speaker Systems

Front, rear, center speakers and the speakers for the DRLC function can be connected to this unit.

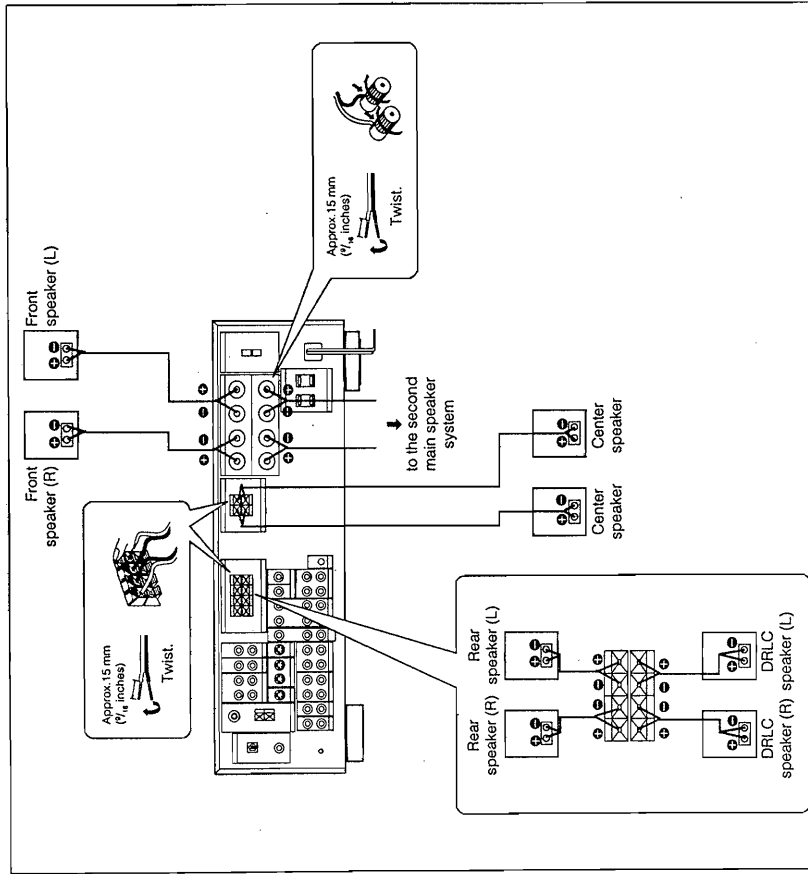

Note

- When connecting the speaker cord to the speaker terminal, make sure that the polarity (+ and -) of the speaker cord is correct. If the polarity is reversed at either speaker, the sound will be distorted and will lack bass.
- When connecting the active speaker incorporated with the power amplifier, connect to the either L or R of CENTER jack.

Speaker impedance and power capability

This receiver is designed to work best with speakers having nominal impedance from 8 to 16 ohms. Be sure to use a speaker system with adequate nominal impedance and power handling capabilities.

Hooking Up the System

Connecting the external power amplifier

By connecting the external power amplifier to this receiver, you can obtain a powerful sound.

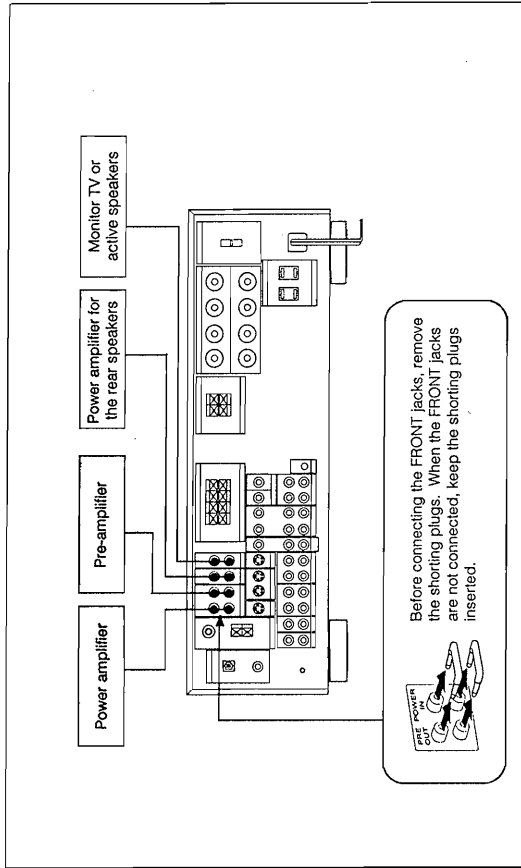

When connecting the amplifiers for the front speakers
 Connect the input jacks of the power amplifier to the FRONT PRE OUT jacks of this receiver and the output jacks of the pre-amplifier to the FRONT POWER IN jacks of this receiver. The powerful sound of the front speakers will be available.

When connecting a power amplifier for the rear speakers
 Connect the input jacks of the power amplifier to the REAR jacks of this receiver.

When connecting a monitor TV or an active speaker as a center speaker
 Connect the input jack of the monitor TV or an active speaker to either L or R of the CENTER jacks of this receiver.

Connecting to the Power Outlet

By connecting the power cord of the other audio equipment to SWITCHED AC OUTLET, this unit can supply the power source to the other audio equipment.

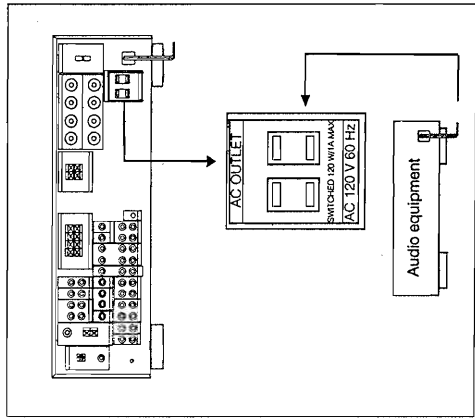

Caution

Be careful that the total power consumption of each equipment connected to the outlets on the receiver does not exceed 120 watts. Do not connect electrical home appliances such as an electric iron, fan, TV, or other high-wattage equipment to these outlets.

Parts Identification

Front Panel

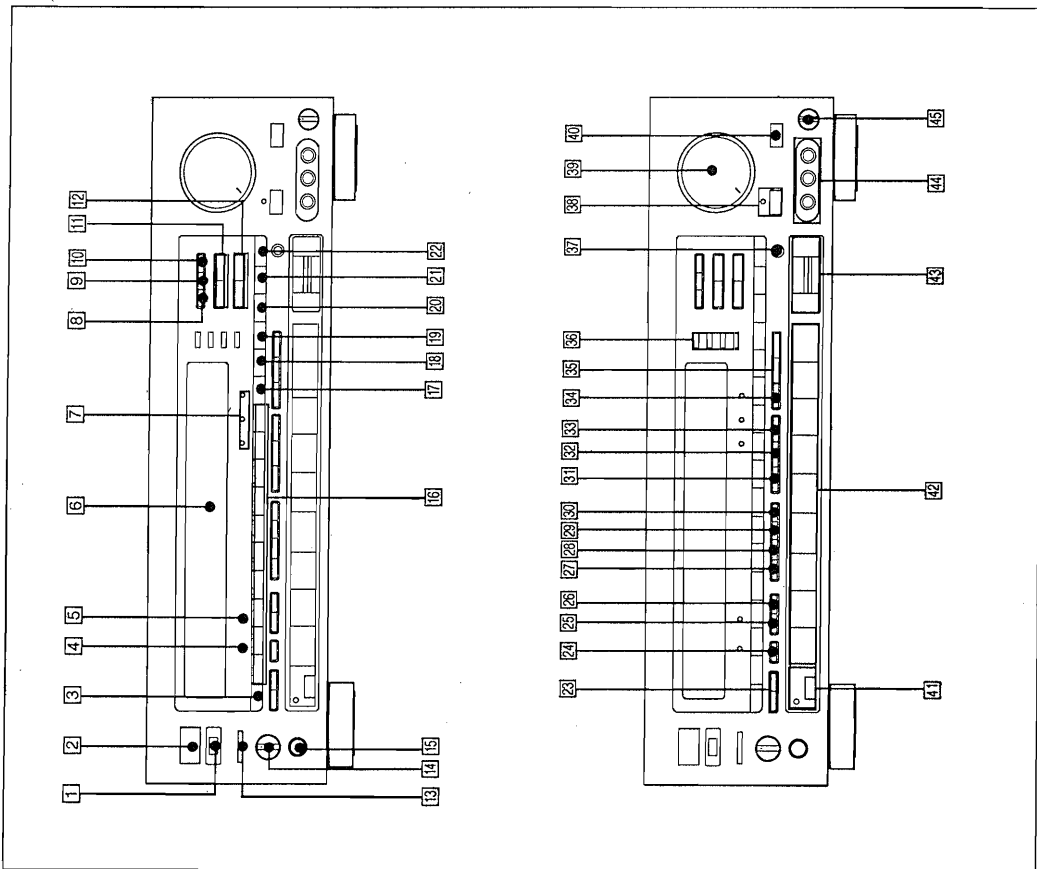

- 1 Remote sensor
- 2 POWER switch
- 3 SHIFT button (See pages 24, 25, 26.)
- 4 ON SCREEN Indicator (STR-D3070X only) (See page 19.)
- 5 TITLE ON Indicator (STR-D3070X only) (See page 42.)
- 6 Display window
- 7 SAMPLING FREQUENCY indicators
- 8 TUNING DIRECT button (See page 22.)
- 9 TUNING LEVEL button (See page 23.)
- 10 DISPLAY FREQ/INDEX button (See pages 23, 26, 27.)
- 11 INDEX SELECT/TUNING \rightarrow / \leftarrow buttons (See pages 23, 27.)
- 12 PRESET TUNING \rightarrow / \leftarrow buttons (See pages 25, 27.)
- 13 DR/LC/POWER switch (See page 44.)
- 14 SPEAKERS selector (See page 19.)
- 15 HEADPHONES jack
- 16 Numeric buttons (See pages 22, 24, 25, 26, 27, 28, 39, 40, 41.)
- 17 MEMORY button (See pages 21, 24, 26, 40, 41.)
- 18 FM MODE button (See pages 22, 24.)
- 19 FM/AM button (See pages 22, 23.)
- 20 SOUND FIELD RECALL button (See pages 28, 40.)
- 21 PRESET SF LINK PGM button (See page 41.)
- 22 PRESET SF LINK ON/OFF button (See page 41.)
- 23 EDIT VIDEO/AUDIO buttons (See pages 30, 31.)
- 24 ON SCREEN ON/OFF button (STR-D3070X only) (See pages 8, 19.)
- 25 TITLE ON/OFF button (STR-D3070X only) (See page 42.)
- 26 TITLE IN/OUT button (STR-D3070X only) (See page 42.)
- 27 EQUALIZER ON/OFF button (See page 38.)
- 28 EQUALIZER BAND button (See page 38.)
- 29 EQUALIZER SLOPE button (See page 38.)
- 30 DISPLAY RTA (Real Time Analyzer) button (See page 38.)
- 31 SURROUND ON/OFF button (See pages 17, 18, 39.)
- 32 SURROUND MODE button (See pages 17, 18.)
- 33 SURROUND PRO LOGIC mode button (See pages 16, 17.)
- 34 SOUND FIELD USER/PRESET button (See pages 28, 40.)
- 35 SOUND FIELD \rightarrow / \leftarrow buttons (See pages 28, 33, 40, 41.)
- 36 CURSOR MODE Indicators (See pages 17, 18, 21, 26, 35, 38.)
- 37 CURSOR MODE/TITLE MENU (STR-D3070X only) button (See pages 17, 18, 21, 26, 35, 38, 39.)
- 38 MUTING button and indicator (See page 19.)
- 39 VOLUME control (See page 19.)
- 40 DDS (Digital Dynamic Sound) button (See page 39.)
- 41 TAPE 2 MONITOR button and indicator (See page 29.)
- 42 Function selectors
- 43 Cursor mode operation buttons (See pages 17, 18, 21, 35, 38, 39, 42.)
- 44 VIDEO 3/INPUT jacks (See page 8.)
- 45 BALANCE control (See page 19.)

Parts Identification

Remote Commander

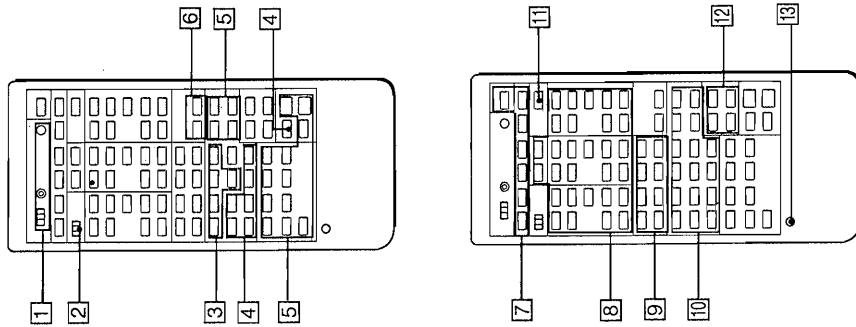

- 1 **Program control block**
Mode selector and indicator (page 46)
SONY STD: To control Sony equipment.
USER STD: To control equipment whose remote control functions are stored.
LEARN: To store functions of other remote commanders emitting infrared rays.
PROGRAM CLEAR button: Clears the stored functions.
- 2 **MODE selector**
1: To select the functions indicated in light gray such as DECK, DAT, CD player and CURSOR/SURROUND mode of the receiver.
2: To select the functions indicated in blue such as VTR, LDP (Laser disc player) and TV.
- 3 **Cursor control block**
CURSOR MODE button: Selects cursor mode.
CURSOR operation buttons
- 4 **Sound control block**
S(sound) FIELD buttons
MODE: Selects sound field mode.
USER/PRESET button: Selects the USER or PRESET mode.
SURROUND buttons
ON/OFF: Turns on/off the surround mode.
MODE: Selects the surround mode.
T. (test) TONE: Generates a pink noise signal that is sent in succession to each speaker.
EQ (equalizer) ON/OFF button: Turns on/off the equalizer.
DDS/DBFB button: Turns on/off the DDS (Digital Dynamic Sound). (The DBFB function is not available with this receiver.)
- 5 **Amplifier block**
FUNCTION selectors: Select an input source of the receiver.
REAR VOL +/- buttons: Control the volume of rear speakers (surround level).
MUTING button: Mutes the sound.
MASTER VOL +/- buttons: Control the receiver volume.
CENTER VOL +/- buttons : Control the volume of center speaker (surround level).
- 6 **ON SCREEN block (STR-D3070X only)**
ON SCREEN ON/OFF button: Turn on/off the ON SCREEN mode.
TITLER ON/OFF button: Turn on/off the TITLER mode.
- 7 **Power control block for other equipment**
SYSTEM OFF button: Turns off the power of the whole system: LDP, VTR, TV and AUDIO.
- 8 **LDP/VTR/TV/AUDIO POWER buttons:** Control the power of each unit.
- 9 **TAPE/DAT/VTR control block**
REC MODE REV/FWD buttons:
For reverse recording, press REV and ● together.
For forward recording, press FWD and ● together.
VTR 1: Betamax VCRs
VTR 2: 8mm VCRs
VTR 3: VHS VCRs
Set to the VTR 1, 2 or 3 according to your VCR setting.
ANT TV/VTR button: Selects the output signal from the antenna terminal on the VCR, either a TV signal or VCR programs.
VTR CH +/- buttons: Select channel on the VCR.
◀◀▶▶: fast winding
●: Recording (Press ● and FWD at the same time.)
▶: Stop
▶▶: Play
||: Pause
- 10 **CD/LDP control block**
◀◀▶▶: Manual search
◀▶▶▶: Locates a desired selection
D (disc) SKIP: Disc skip (for a CD player equipped with a multi-disc changer)
▶: Play
▶▶: Stops play.
||: Pause
- 11 **TV control block**
Program number (1 to 0) and ENTER buttons: Select the channel.
TV/VIDEO selector: Selects the program to see : TV or VIDEO.
TV VOL +/- buttons: Control the TV volume.
TV CH +/- buttons: Select a preset channel.
- 12 **SLEEP button**
Set to the SLEEP timer mode. In this mode, the unit is automatically turned off after the designated time. (page 20)
- 13 **Tuner block**
INDEX SEL (select) button: Select an indexed preset station.
SHIFT and PRESET +/- buttons: Select a preset station.
- 14 **RESET button**
Reset the commander to the initial state. If the remote commander does not function correctly after replacing the batteries with new ones, press this button.

Note:
When the ◀▶ (play) buttons in 10 and the SHIFT button and PRESET +/- buttons in 13 are pressed, the unit enters the corresponding function mode without pressing the FUNCTION buttons in 9, if the CD player is connected to the CD jacks, the

tape deck to the TAPE jacks and the video deck to the VIDEO 1 jacks (switch the DECK/VCR selector on the remote commander to VTR 1).

SECTION 2 ELECTRICAL ADJUSTMENT

FE001 FM front-end and FE002 AM front-end are adjusted Perfectly and are supplied as unit for replacement.

FM SECTION

Connecting:

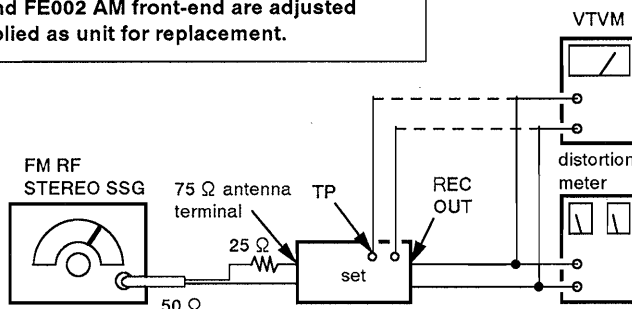

	Null & Mono Distortion	Stereo Separation	Muting Level
Carrier frequency	98MHz		
Output level	60dB (1mV)		
Modulation	1kHz, 75kHz deviation	1kHz, 33.75kHz deviation sub carrier 38kHz, 33.75kHz deviation pilot 19kHz, 7.5kHz deviation	1kHz, 75kHz deviation
Adjustment Location	T001/T002	RT004	RT002
Test Point (TP) or Jack	TP001/REC out	REC OUT	D003 (Cathode)

Null and Mono Distortion Adjustment

Setting:

FUNCTION selector: TUNER
BAND selector: FM
FM MODE: MONO

Procedure:

1. Tune the set to 98MHz.
2. Adjust T001 so that the voltage of TP001(Null) becomes 0V (within $0 \pm 50\text{mV}$)
3. Adjust T002 so that the distortion at REC OUT becomes minimum. (Not more than 0.3%)
4. Repeat the procedures 2. and 3. several times.

• FM Stereo Operation Level Adjustment

Setting:

FM RF stereo signal generator

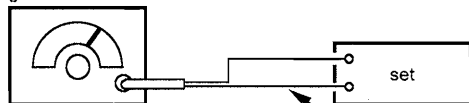

Carrier frequency: 98MHz
Output level: 25dB μ
Modulation: 1kHz, 75kHz dev.
(100%)

Procedure:

1. Tune the set to 98MHz.
2. Adjust RT003 that the STEREO LED goes on.

Stereo Separation Adjustment

- This adjustment should be performed after Mono Distortion Adjustment.

Setting:

FUNCTION selector: TUNER
BAND selector: FM
FM MODE: STEREO

Procedure:

Tune the set to 98MHz

FM stereo signal generator output channel	VTVM connection	VTVM reading (dB)
L-CH	L-CH	Ⓐ
R-CH	L-CH	Ⓑ [Ⓐ] Adjust RT004 for minimum reading
R-CH	R-CH	Ⓒ
L-CH	R-CH	Ⓓ [Ⓒ] Adjust RT004 for minimum reading

L-CH Stereo separation : Ⓐ - Ⓑ ($\geq 40\text{dB}$)
R-CH Stereo separation : Ⓒ - Ⓓ ($\geq 40\text{dB}$)

The separations of both channels should be equal

• Auto Stop Level Adjustment

Setting:

FM RF stereo signal generator

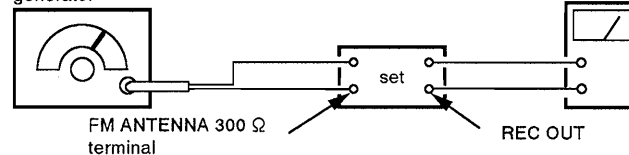

Carrier frequency: 98MHz
Output level: 40dB μ or 45dB μ

Procedure:

1. Turn the High/Low select switch to High.
2. Adjust RT002 so that the TUNED LED goes on.

AM SECTION

Tuned Level Adjustment

Setting:

FUNCTION selector: TUNER
 BAND selector: AM

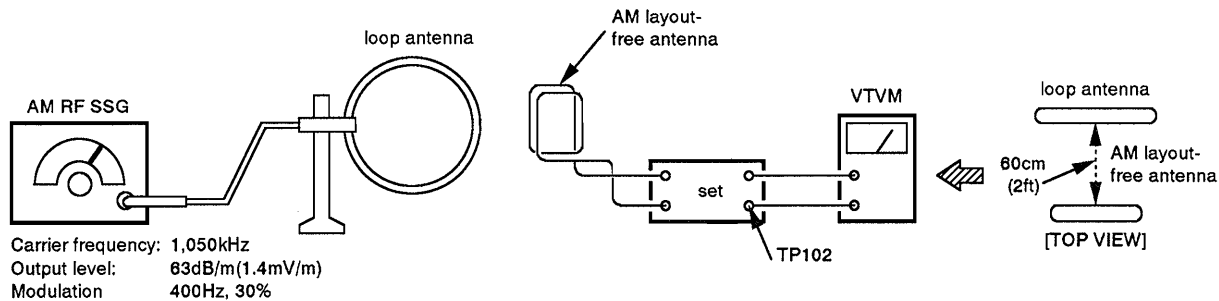

Procedure:

Adjust RT001 to the point where the voltage fo D003(cathode)turns from hight level to low.

Adjustment Location:

[TUNER BOARD] – Component side –

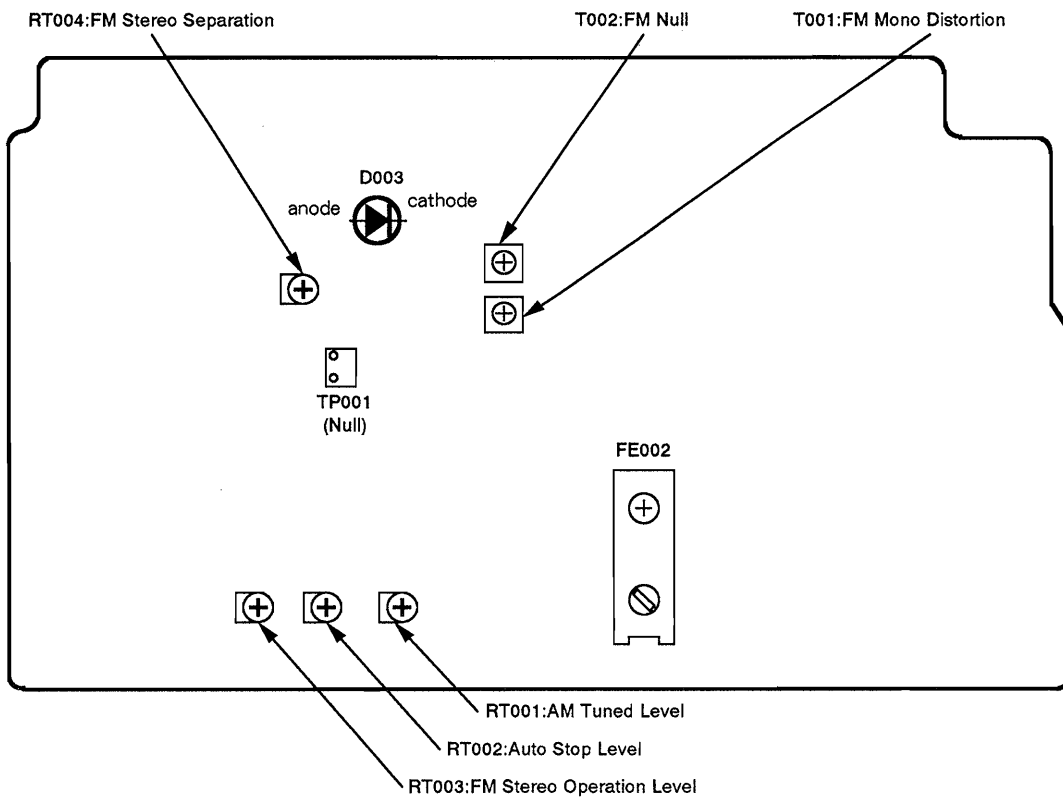

AMP SECTION**DC Bias Adjustment**

- Perform this adjustment after replacement of power amp or drive circuit transistors.

Setting:

VOLUME: 0
SPEAKERS: OFF(no load)

Procedures:

1. Connect the digital voltmeter to Bias Test Point(TP701 ①, ②:L-CH, TP701 ③, ④:R-CH)
2. Increase the AC power voltage gradually to 120V confirming that the voltmeter will not indicate an abnormal value.

3. Confirm that the display is normal.
4. Adjust RT701(L-ch) or RT751(R-ch) so that the reading on the voltmeter becomes 0.7mV within 30 seconds after the power turned on.

Note: It is normal that the voltage will increase as time passes.

5. Turn the power off and remove the digital voltmeter.

Adjustment Location:

[MAIN BOARD] – Component side –

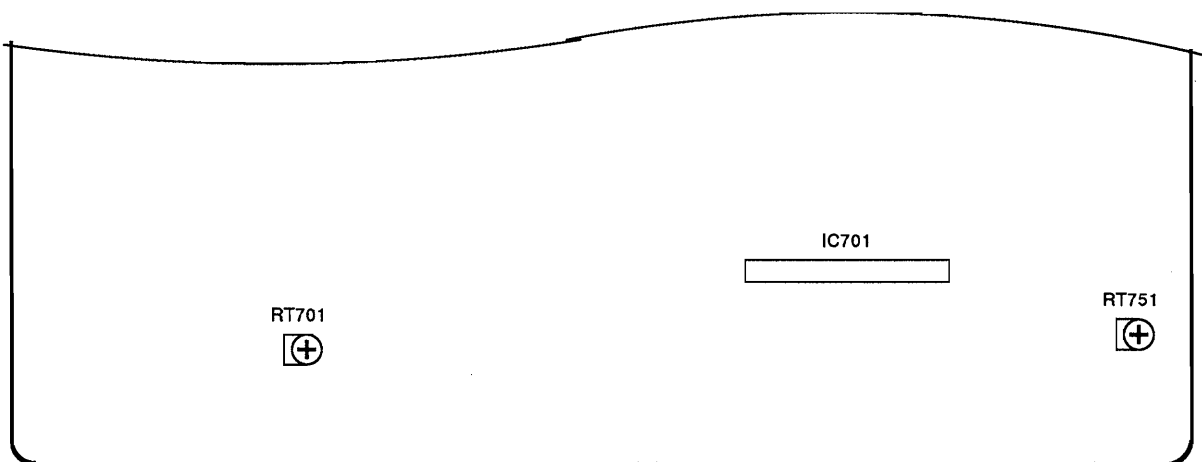

[SURROUND POWER BOARD] – Component side –

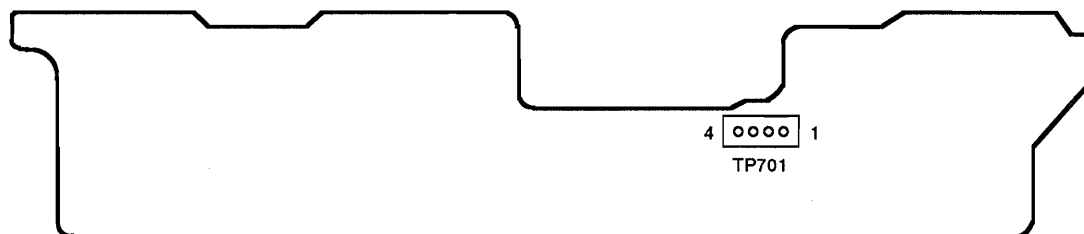

ONSCREEN SECTION

Color Burst Signal Adjustment

Setting:

Signal: None
 Frequency counter: TP101

Procedure:

Adjust to 3.579545MHz with CT101

H.sync Signal Adjustment

Setting:

Signal: None
 Frequency counter: TP106

Procedure:

Adjust to 15.734kHz with RV105

Color Reproducibility Adjustment

Procedure:

1. Push **RTA** and **7** buttons at once while pushing **TAPE 2** button
2. Adjust the picture frame as shown in Fig. A when using a color bar chart for adjustment with RV104

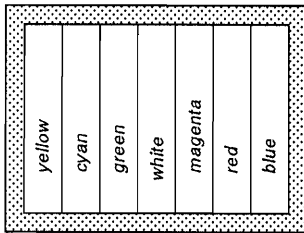

Fig. A. (picture of monitor screen)

Clock-High Adjustment

Setting:

Signal: None
 Frequency counter: TP103

Procedure:

1. Short TP104 and GND
2. Adjust to 23.5MHz with RV105

Clock-Low Adjustment

Setting:

Signal: None
 Frequency counter: TP103

Procedure:

1. Short TP105 and GND
2. Adjust to 18.9MHz with RV106

**Adjustment Location:
 [ONSCREEN BOARD]**

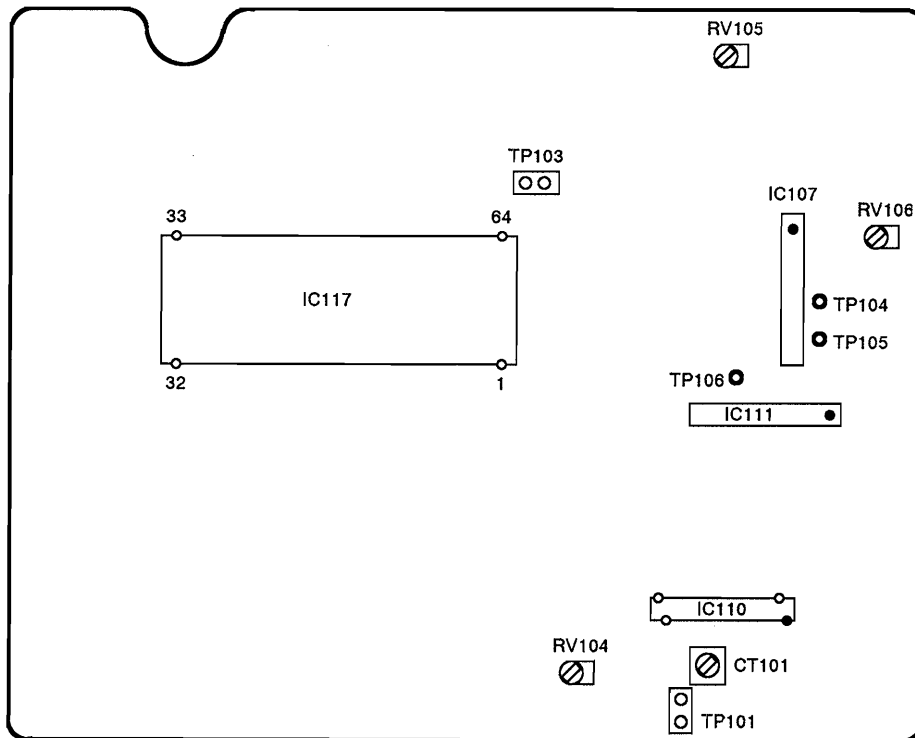

SECTION 3 DIAGRAMS

3-1. CIRCUIT BOARDS LOCATION

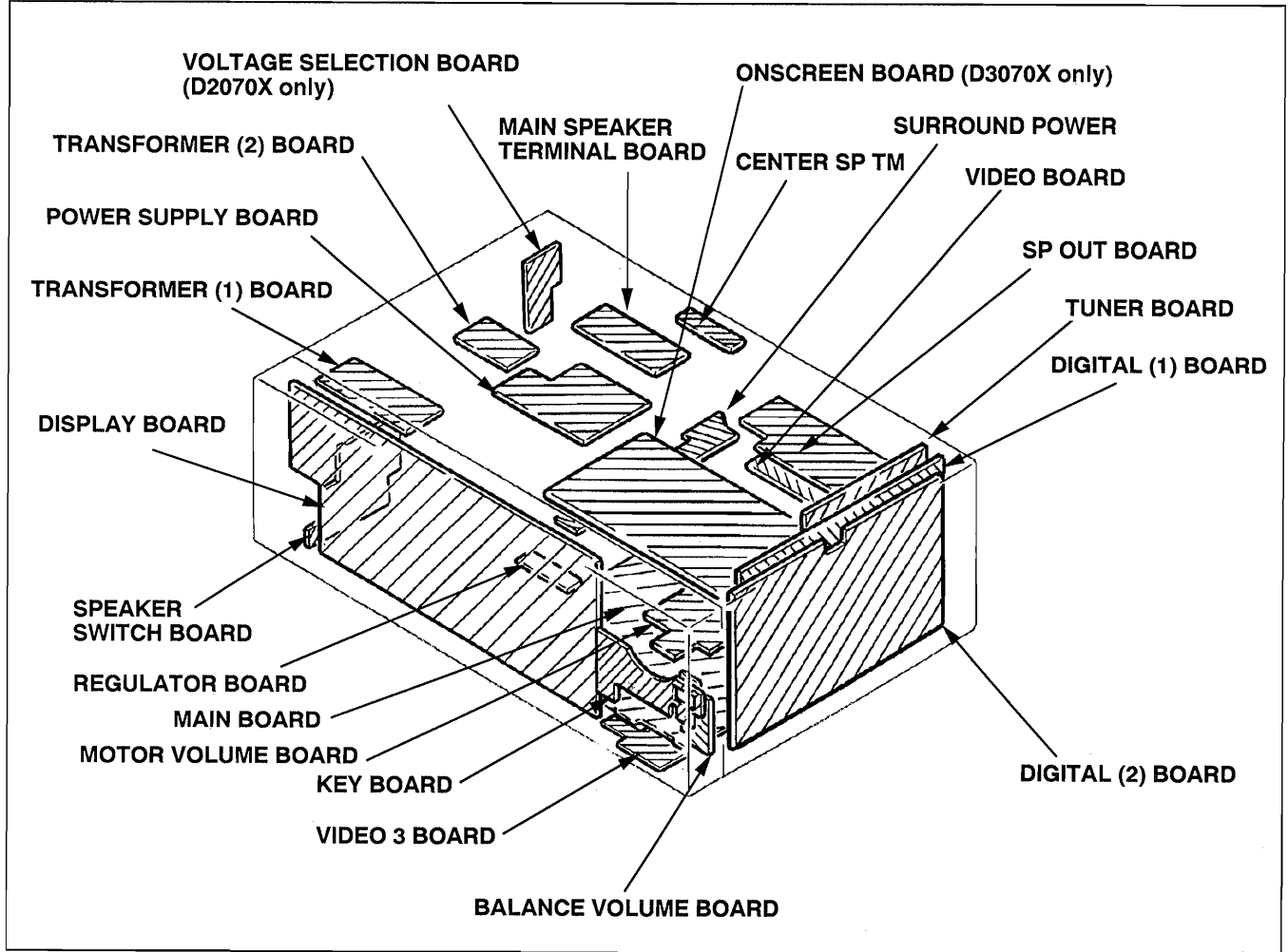

3-2. SEMICONDUCTOR LEAD LAYOUTS

BA7230LS



RC79L05A

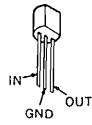

2SC1841-PAFAEA
2SC3112-B



1SS120
1SS168
11ES2
HZS6A1L
HZS6C3L

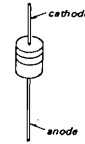

SEL2810A

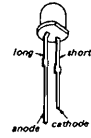

BA7611AN
NJM4580L

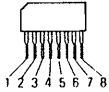

SI18752N

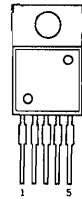

2SC2603-EF



HZ4ALL

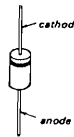

SEL3810A-CD

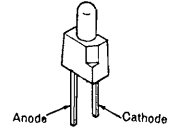

LM7805CT

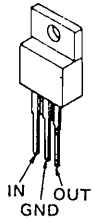

2SC3623A-L



KV1310

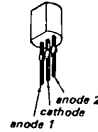

XR-1092

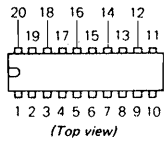

LVA519S
TC5081AP



2SK241-GR



MC921



2SA988-PAFAEA



M5F78M15

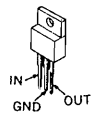

2SK246-GR3



RBA-402

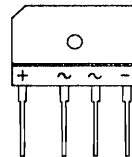

2SA1175-HFE



M5F79M15

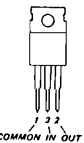

FA1A4M-L33
FN1A4M-T1M33



SEL2210S-C

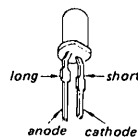

RC78L05A



2SA1684-LK
2SC4431-LK
2SD2012

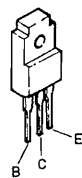

3-4. PRINTED WIRING BOARDS(1) • Refer to Page 14 for Semiconductor Layout.

Note:

- — : parts extracted from the component side.
- : parts mounted on the conductor side.
- ⊙ : indicates side identified with part number.

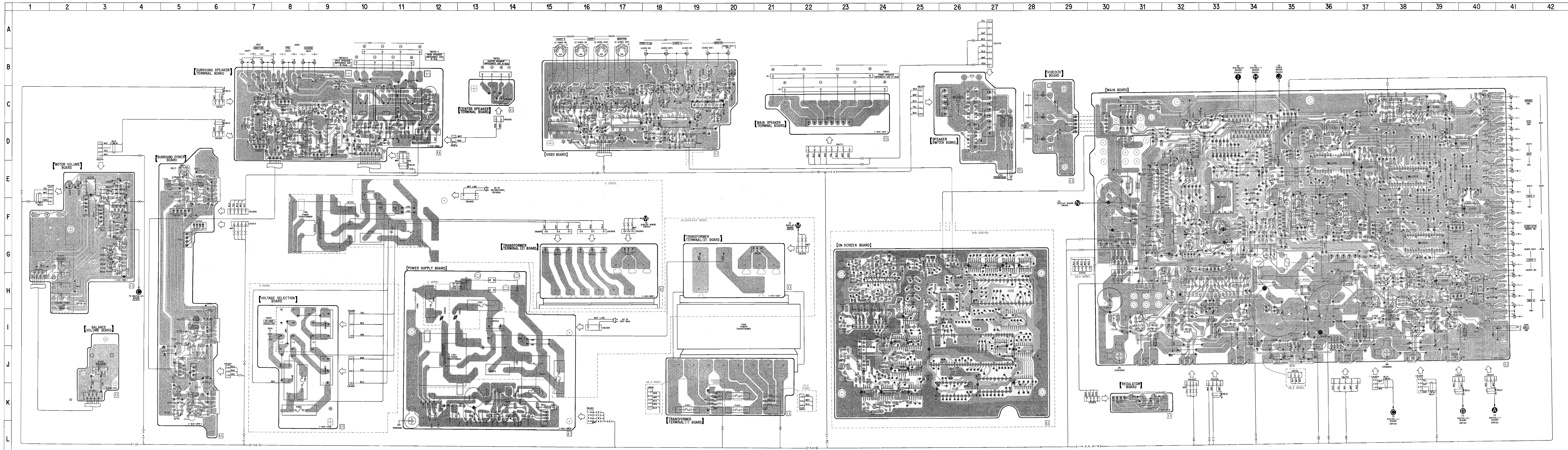

- Note:**
- All capacitors are in μF unless otherwise noted, pF: μpF 50WV or less are not indicated except for electrolytics and tantalums.
 - All resistors are in Ω and $\frac{1}{2}\text{W}$ or less unless otherwise specified.
 - Δ : internal component.
 - \square : nonflammable resistor.
 - $\text{---}/\text{---}$: fusible resistor.

Note: The components identified by mark Δ or dotted line with mark Δ are critical for safety. Replace only with part number specified.

Note: Les composants identifiés par une marque Δ ou par une ligne pointillée avec une marque Δ sont critiques pour la sécurité. Ne les remplacer que par une pièce portant le numéro spécifié.

- : B+ Line
- : B- Line
- : Voltage and waveforms are dc with respect to ground under no-signal (detuned) conditions, no mark: FM
- : Voltages are taken with a VOM (input impedance 10M Ω). Voltage variations may be noted due to normal production tolerances.
- : Signal path
- : FM

• SEMICONDUCTOR LEAD LAYOUTS

Ref. No.	Location	Ref. No.	Location	Ref. No.	Location	Ref. No.	Location
D101	D-18	D607	K-12	IC621	G-32	Q716	G-34
D102	D-18	D608	K-13	IC701	H-33	Q740	E-5
D240	E-3	D809	K-13	IC702	E-6	Q741	K-5
D241	E-3	D810	K-13	IC703	K-6	Q742	D-11
D603	G-37	D815	K-12	IC704	I-6	Q743	D-11
		D816	K-12				
D604	G-34			Q745	D-10		
D605	F-34	D817	K-12	Q101	C-17	Q752	J-32
D606	G-34	D818	K-12	Q102	C-16	Q754	I-32
D607	E-32			Q103	C-18	Q755	J-31
D609	F-34			Q104	C-16	Q759	J-34
				Q105	C-18		
D610	H-32	IC003	E-18			Q767	I-31
D614	E-32	IC102	D-15	Q106	C-19	Q768	I-34
D615	F-32	IC103	C-18	Q108	D-16	Q791	I-5
D616	G-32	IC104	C-19	Q109	C-16	Q801	K-15
D617	K-31			Q110	C-20	Q802	K-14
				Q112	H-23		
D619	G-31	IC105	K-24			Q803	K-13
D621	G-34	IC107	I-24	Q113	G-23	Q804	K-13
D622	F-34	IC108	K-25	Q114	G-23	Q805	K-14
D623	F-34	IC110	H-24	Q115	J-24	Q806	K-14
D701	I-38			Q116	H-24	Q822	D-8
				Q117	H-23		
D702	I-39	IC111	I-25				
D703	I-39	IC114	J-24	Q118	I-26		
D704	I-39	IC115	I-25	Q119	J-24		
D707	I-38	IC117	J-26	Q120	G-24		
D708	I-37			Q142	E-34		
				Q240	F-3		
D709	I-37	IC118	K-26				
D712	I-38	IC119	K-27	Q601	H-40		
D719	I-36	IC121	K-28	Q804	C-9		
D715	H-37	IC122	H-27	Q805	C-9		
D716	I-39			Q806	C-9		
				Q807	C-9		
D718	G-34	IC123	G-28	Q808	C-9		
D719	G-35	IC124	G-27	Q809	D-8		
D720	H-38	IC125	H-26	Q810	C-8		
D722	G-30	IC126	G-26	Q812	G-32		
D721	J-35	IC127	J-25	Q813	C-9		
				Q814	F-32		
D723	H-38	IC129	G-27	Q815	F-32		
D740	E-5	IC130	J-27	Q816	G-32		
D741	K-5	IC171	I-24	Q817	I-24		
D742	D-11	IC231	E-35	Q818	H-38		
D743	D-11			Q819	G-33		
D744	D-11	IC240	G-4				
D745	I-31	IC241	E-3				
D746	D-10	IC602	D-40	Q620	H-38		
D747	D-10	IC603	F-40	Q621	G-37		
D748	D-11			Q622	F-35		
				Q624	C-7		
D749	D-10	IC604	H-39	Q625	C-8		
D751	I-32	IC605	D-8	Q626	D-8		
D752	I-31	IC607	E-37	Q627	D-8		
D753	I-31	IC608	E-36	Q628	H-38		
D754	I-31			Q702	J-38		
				Q704	J-39		
D757	I-33	IC610	F-36				
D758	I-33	IC611	F-36	Q705	J-39		
D759	I-33	IC612	D-9	Q708	I-38		
D760	I-34	IC613	E-33	Q709	J-37		
D763	I-32			Q711	H-37		
				Q712	I-39		
D765	H-34	IC616	D-31				
D766	I-31	IC617	C-31	Q713	H-38		
D791	I-5	IC618	H-31	Q714	H-39		
D802	K-14	IC619	D-36	Q715	H-38		

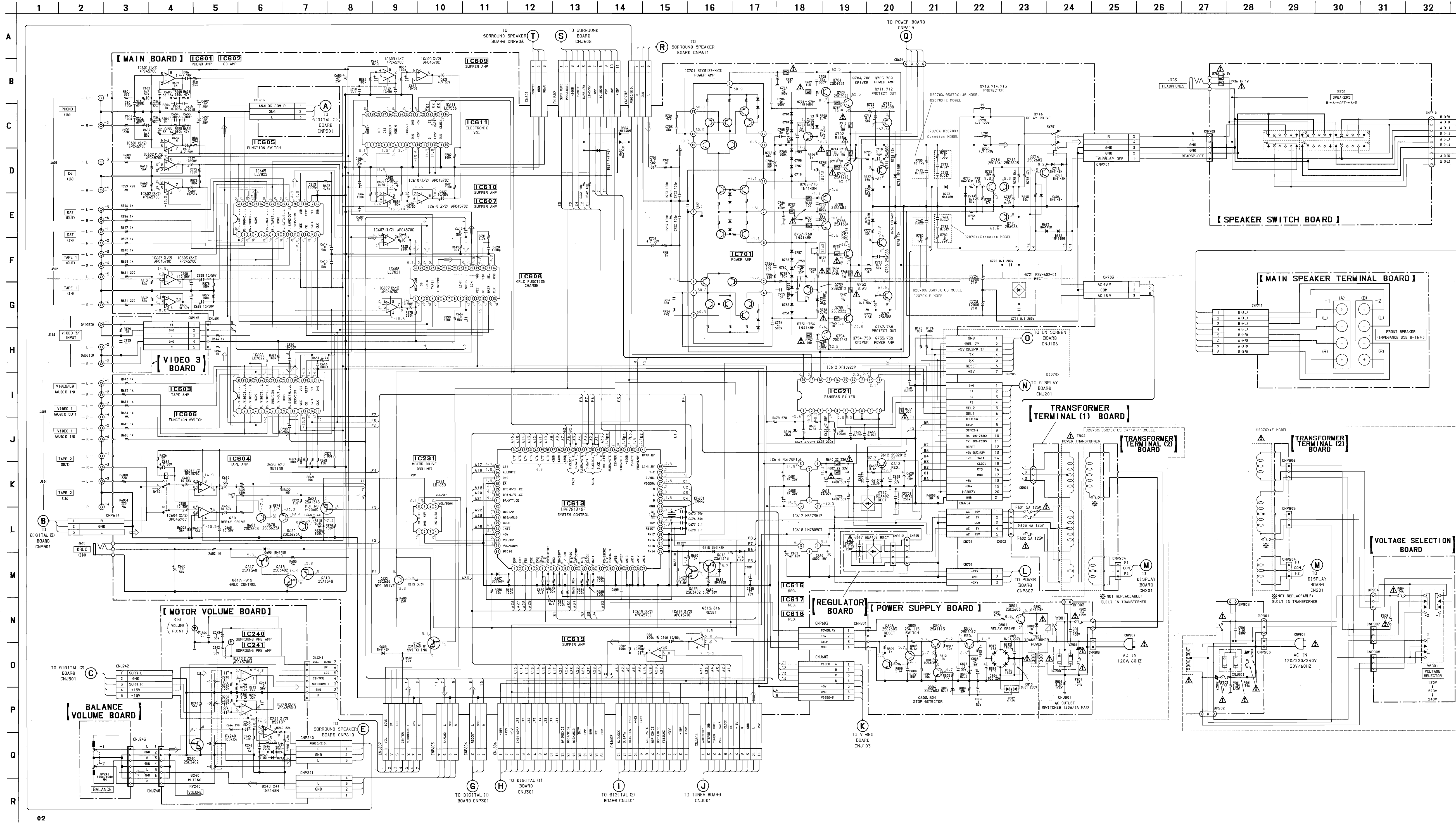

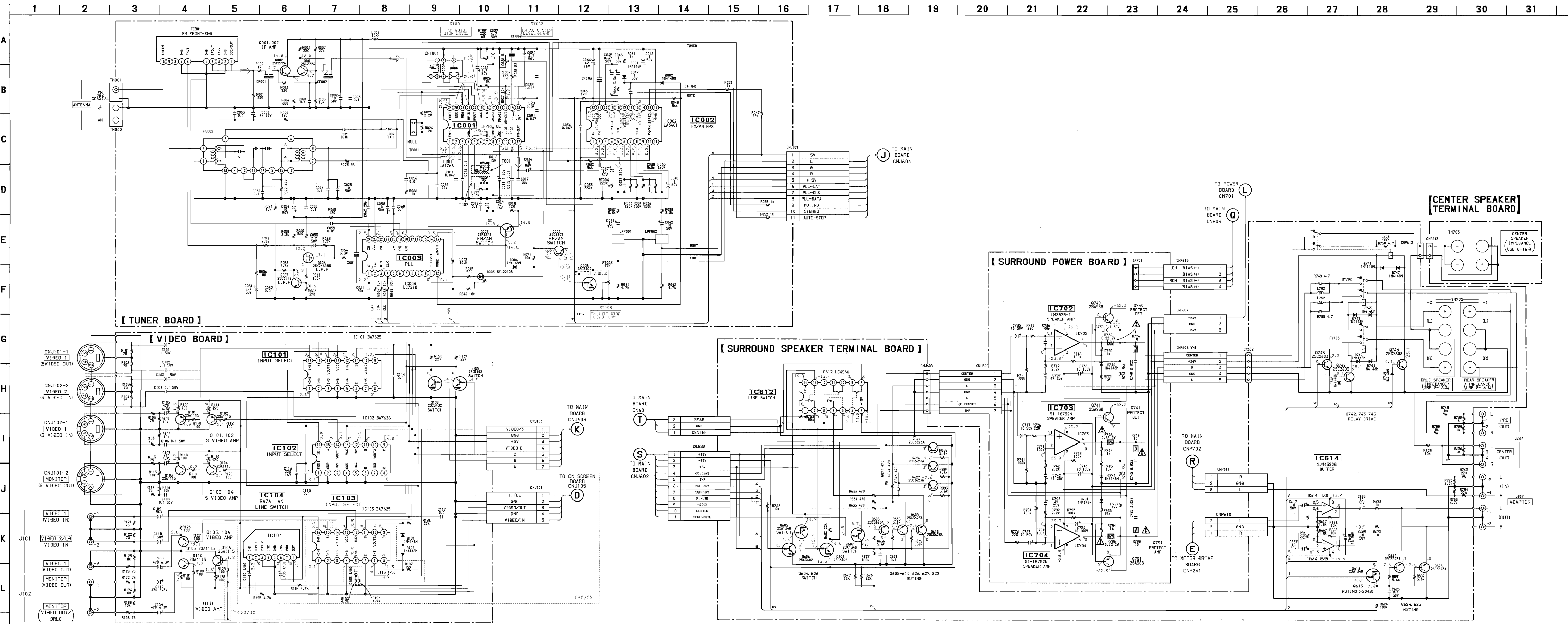

Note:

- All capacitors are in μF unless otherwise noted. $\text{pF} = \mu\text{F}$ 50V or less are not indicated except for electrolytics and tantalums.
- All resistors are in Ω and $1/4\text{W}$ or less unless otherwise specified.
- Δ : internal component.
- \square : nonflammable resistor.
- $\text{---}/\text{---}$: fusible resistor.

Note:

The components identified by mark Δ or dotted line with mark Δ are critical for safety. Replace only with part number specified.

Note:

Les composants identifiés par une marque Δ sont critiques pour la sécurité. Ne les remplacer que par une pièce portant le numéro spécifié.

- $\text{---}/\text{---}$: B+ Line
- $\text{---}/\text{---}$: B- Line
- Voltage and waveforms are dc with respect to ground under no-signal (detuned) conditions.
- no mark: FM
- (): AM
- Voltagés are taken with a VOM (input impedance 10M Ω). Voltage variations may be noted due to normal production tolerances.
- Signal path.
- $\text{---}/\text{---}$: FM

● SEMICONDUCTOR LEAD LAYOUTS

Ref. No.	Location	Ref. No.	Location
D001	C-16	IC315	B-12
D002	C-16	IC316	E-3
D003	E-17	IC317	D-3
D004	E-18	IC318	D-4
D201	J-21	IC319	B-3
D202	I-21	IC400	H-6
D203	J-24	IC401	H-8
D204	J-24	IC402	G-8
D205	J-24	IC403	I-7
D206	I-24	IC404	G-19
D207	I-22	IC405	G-10
D208	I-22	IC406	J-9
D209	I-21	IC407	J-10
D210	I-17	IC408	H-9
D211	I-16	IC409	I-9
D213	G-15	IC501	H-7
D214	I-13	IC502	H-11
D215	I-13	IC503	G-6
D219	H-22	IC504	G-4
D221	I-21	IC505	I-6
D222	J-14	IC506	I-4
D223	G-25	IC551	J-7
D231	D-23	IC553	H-6
D301	B-9	IC554	H-4
D302	B-8	IC555	J-6
D303	E-9	IC556	J-4
D304	C-6		
D305	D-8		
D306	D-10	Q001	D-19
D351	C-9	Q002	D-19
		Q003	E-18
D352	C-8	Q004	E-17
D401	J-2	Q005	B-10
D402	J-3		
D403	K-8	Q006	E-19
D404	H-8	Q007	E-20
		Q201	I-17
D405	I-9	Q202	I-17
		Q302	E-8
IC001	C-18	Q403	I-8
IC002	C-16	Q404	I-8
IC201	J-16	Q405	I-11
IC202	J-20	Q501	G-3
IC203	J-22	Q502	G-3
IC204	J-13	Q503	G-3
IC301	B-10	Q504	H-2
IC302	B-8	Q506	I-3
IC303	E-5	Q507	J-2
IC304	B-7	Q508	J-2
IC305	B-7	Q509	I-2
IC306	C-7	Q510	J-2
IC307	C-8	Q511	G-3
IC308	C-9	Q512	I-3
IC309	E-9	Q551	H-3
IC310	D-10	Q552	H-3
IC311	D-11	Q553	H-3
IC312	C-11	Q554	I-2
IC313	D-5	Q556	I-3
IC314	E-5	Q561	H-2
		Q562	I-3

Note:
 ● ○ — : parts extracted from the component side.
 ● ■ — : parts mounted on the conductor side.
 ● ○ — : indicates side identified with part number.

3-8. PRINTED WIRING BOARDS(2) ● Refer to Page 14 for Semiconductor Layout.

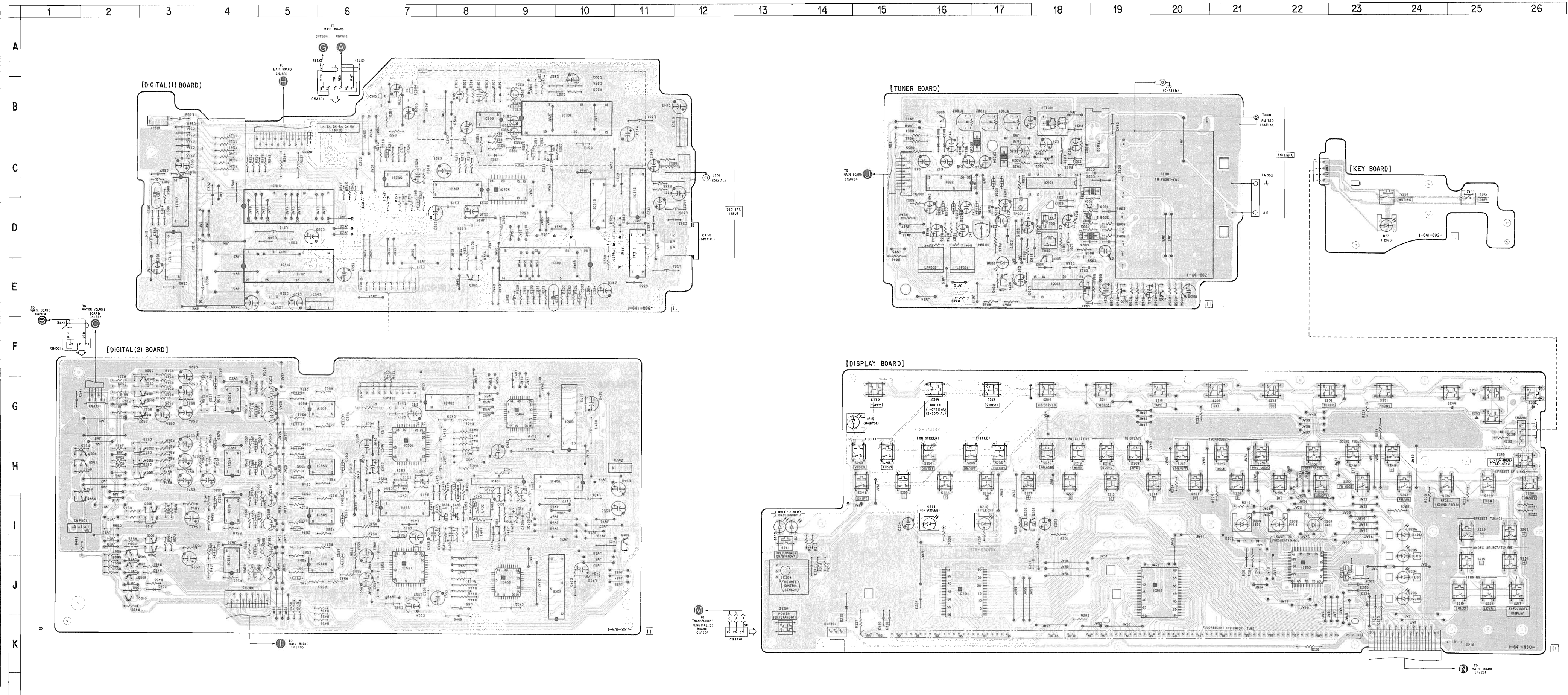

3-9. SCHEMATIC DIAGRAMS(4) • Refer to Page 53 for IC BLOCK Diagrams.

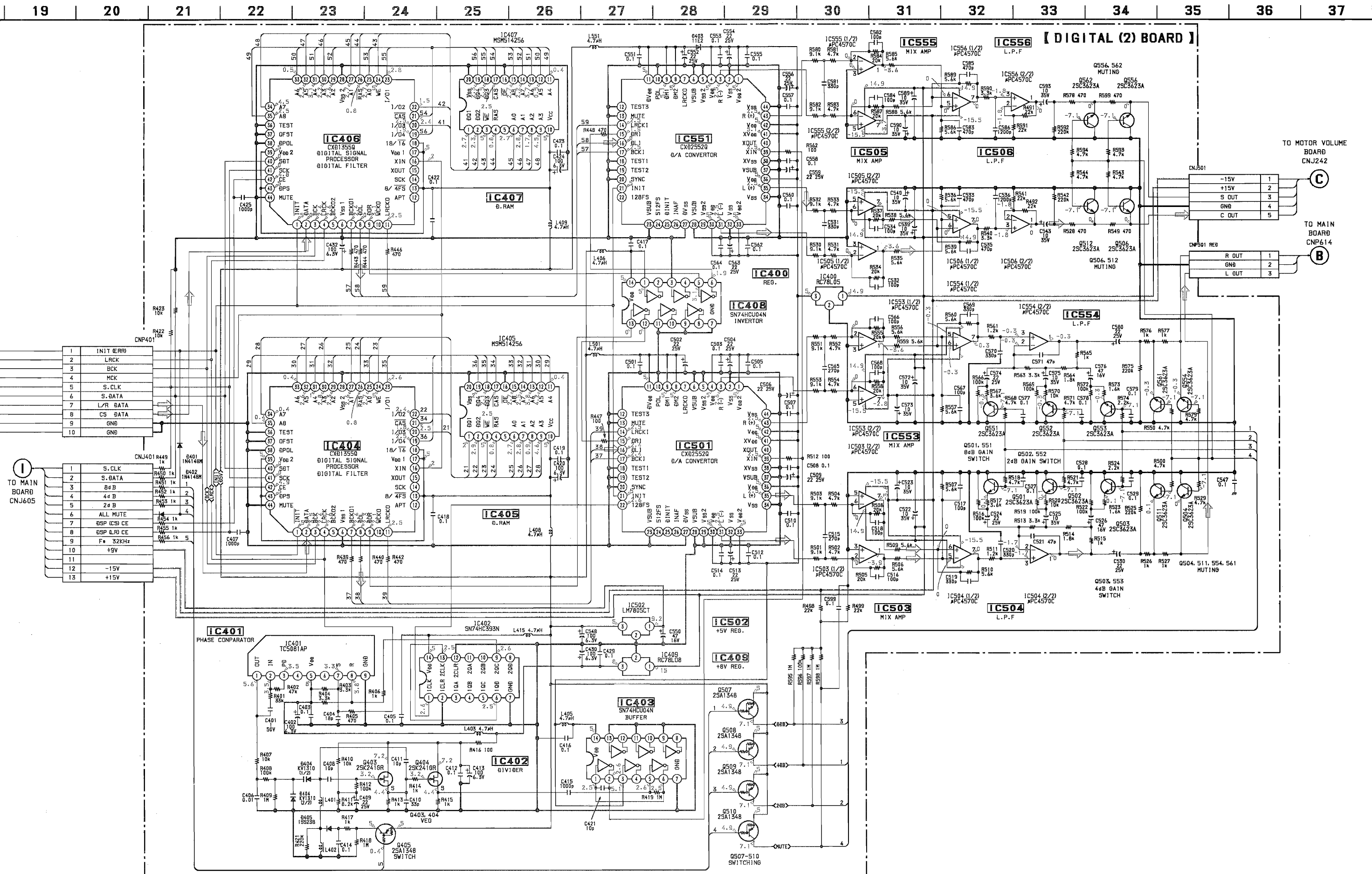
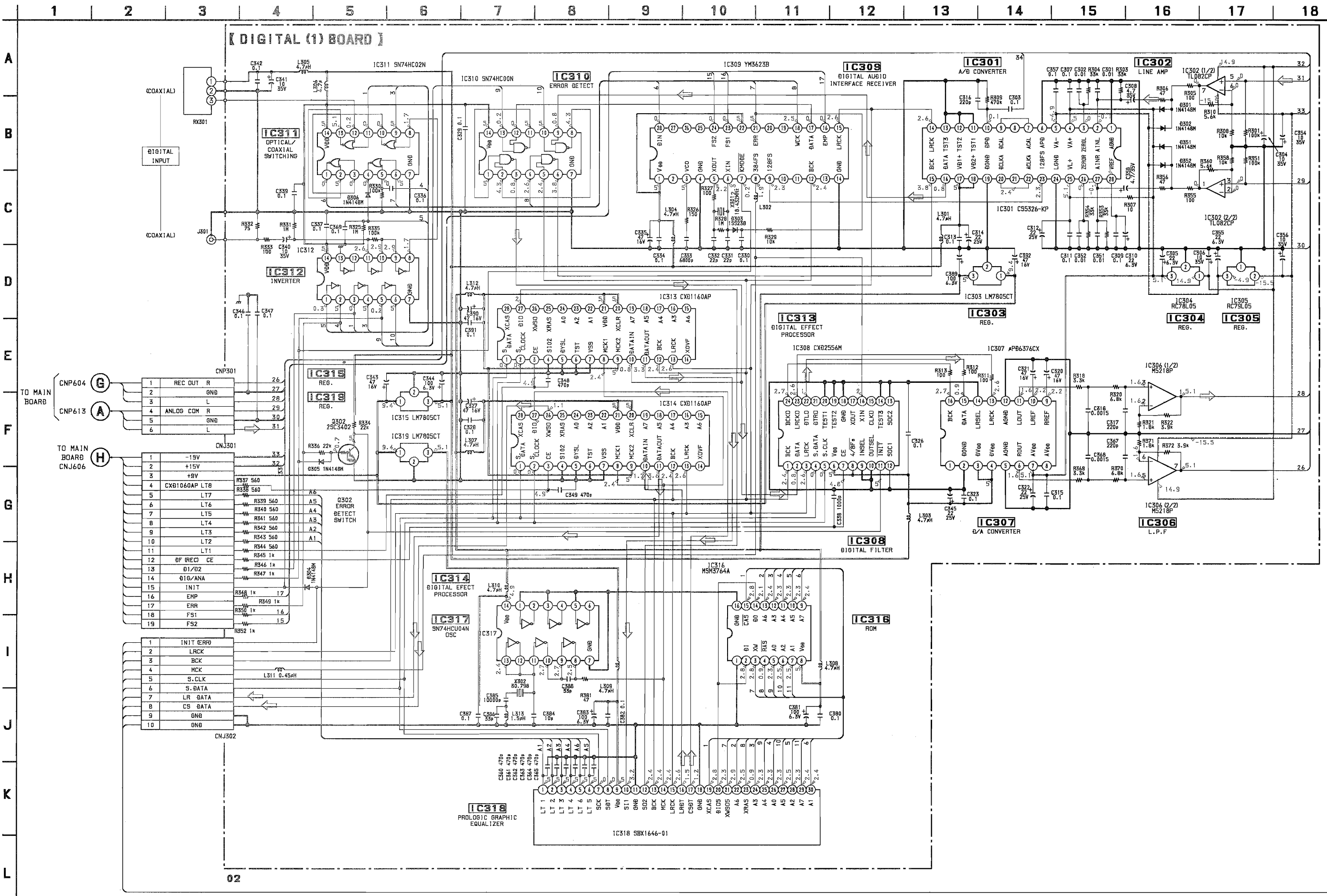

- Note:**
- All capacitors are in μF unless otherwise noted. pF: μpF 50WV or less are not indicated except for electrolytics and tantalums.
 - All resistors are in Ω and $\frac{1}{2}W$ or less unless otherwise specified.
 - Δ : internal component.
 - \square : nonflammable resistor.
 - --- : fusible resistor.

Note:
 The components identified by mark Δ or dotted line with mark Δ are critical for safety. Replace only with part number specified.

Note:
 Les composants identifiés par une marque Δ ou une ligne pointillée avec une marque Δ sont critiques pour la sécurité. Ne les remplacer que par une pièce portant le numéro spécifié.

- \circ : B+ Line
- \bullet : B- Line
- Voltage and waveforms are dc with respect to ground under no-signal (detuned) conditions.
- no mark: FM
- (): AM
- Voltages are taken with a VOM (Input Impedance 10M Ω). Voltage variations may be noted due to normal production tolerances.
- Signal path.
- --- : FM

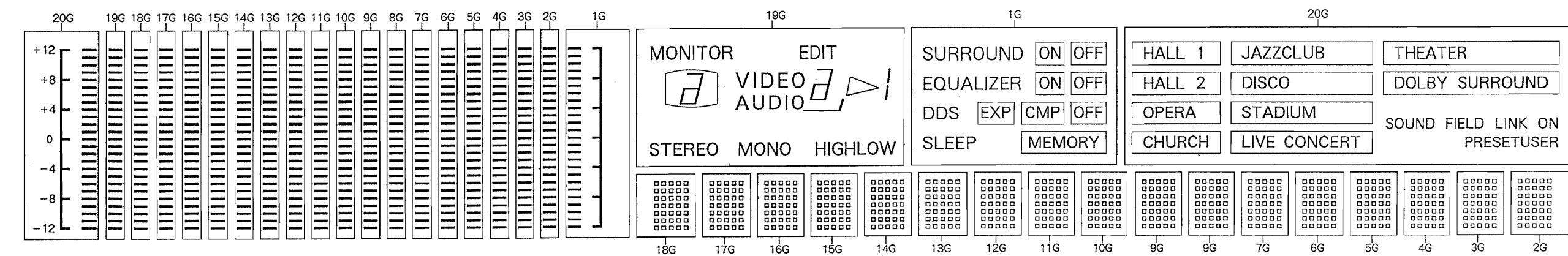

Note:

- All capacitors are in μF unless otherwise noted. pF: μF 50WV or less are not indicated except for electrolytics and tantalums.
- All resistors are in Ω and $\frac{1}{4}\text{W}$ or less unless otherwise specified.
- \triangle : internal component.
- \square : nonflammable resistor.
- \square : fusible resistor.

Note:
The components identified by mark Δ or dotted line with mark Δ are critical for safety. Replace only with part number specified.

Note:
Les composants identifiés par une marque Δ sont critiques pour la sécurité. Ne les remplacer que par une pièce portant le numéro spécifié.

- \circ : B+ Line
- \circ : B- Line
- Voltage and waveforms are dc with respect to ground under no-signal (detuned) conditions.
- no mark: FM
- (): AM
- Voltages are taken with a VOM (Input Impedance 10M Ω). Voltage variations may be noted due to normal production tolerances.
- Signal path
- \Rightarrow : FM

3-10. SCHEMATIC DIAGRAMS(5) • Refer to Page 53 for IC BLOCK Diagrams.

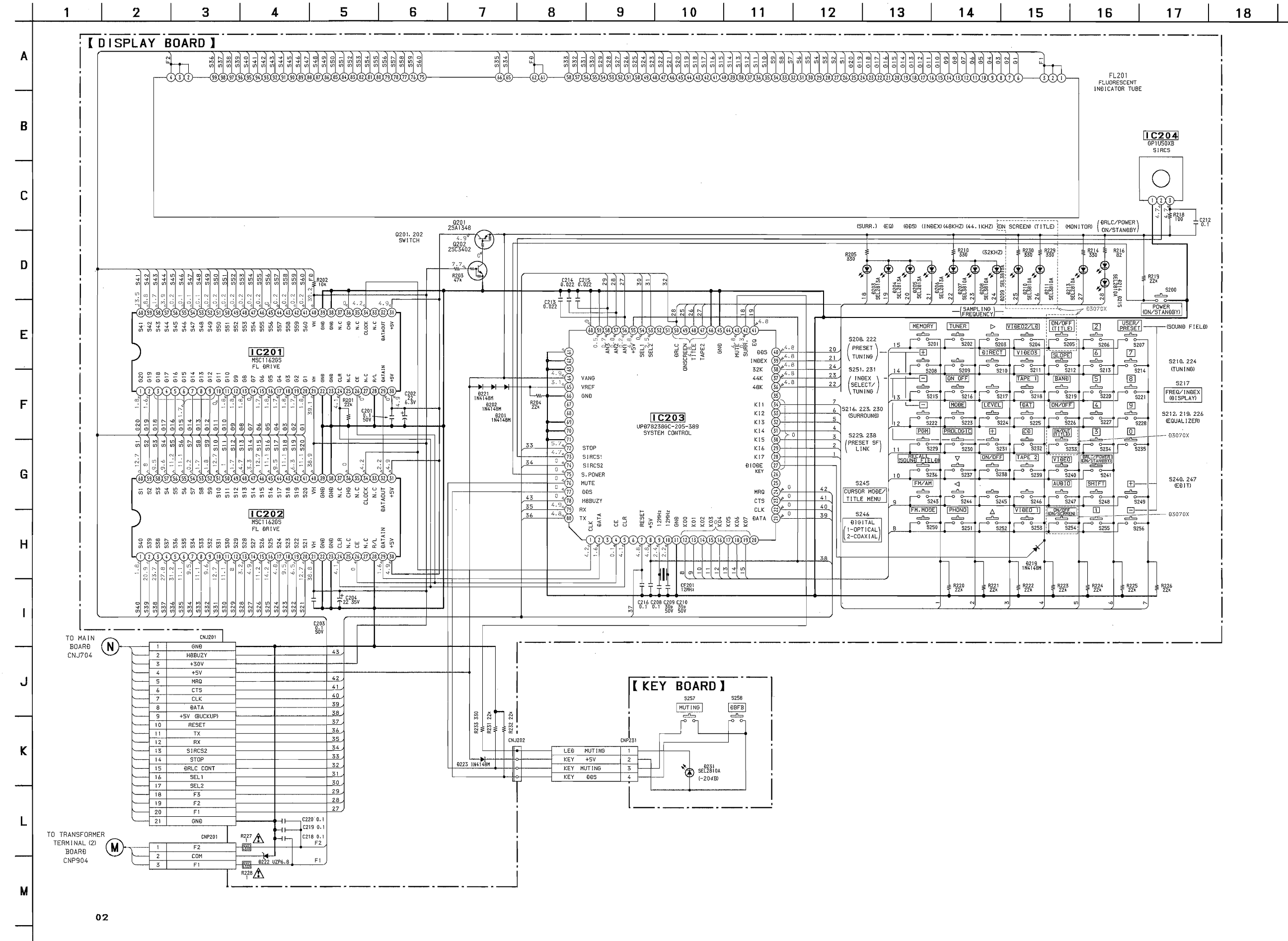

IC313, 314 Digital • Audio Signal Processing LSIs CXD1160 AP

These are digital • audio signal processing LSIs which incorporate instruction RAM, coefficient RAM, data RAM, multiplier and level shifter and are equipped with serial I/O, delay I/O (max. capability : stereo 1024 sampling • delay) and microcomputer interface for peripheral devices.

Pin No.	Symbol	I/O	Description
1	SDT	I	Serial • data input terminal to receive instructions, coefficients, I/O controls transferred from the microcomputer.
2	SCK	I	SDT serial • clock input terminal to fetches in data at a rise.
3	XSLD	I	Input terminal for a latch signal from the system microcomputer to latch serial • data inside the IC. LOW active (LCK for DPAC1).
4	SIO2	I	Input terminal to set the number of serial bit clocks BCK in each channels (ch1 or ch2) data transfer in one sampling section. 32-bit clock mode when fixed at GND, and 24-bit clock mode when fixed at +5V. (32 bits for this set)
5	DYSL	I	Delay I/O mode selector input terminal. Serial mode when fixed at GND, and similar operation to serial I/O. Delay mode when fixed at +5V, and a delay line equivalent to 2-channels is configured by connecting to external DRAM (64kbits).
6	TST	I	Test pin. Normally, fix at GND.
7	VSS		GND terminal.
8	MCK1	I	Master clock input 1. The master clock ACK inside the IC is half this frequency. Fix MCK2 at +5V when inputting the master clock from MCK2.
9	MCK2	I	Master clock input 2. The master clock ACK inside the IC is the same frequency as this. Fix MCK1 at +5V or GND when inputting the master clock from MCK 2.
10	SI	I	1-sampling 2-channel serial data input terminal.
11	SO	O	1-sampling 2-channel serial data output terminal.
12	BCK	I	Serial bit clock input terminal for SI and SO. Serial input data is fetched in at a rise of this BCK and output data is sent out. (64FS)
13	LRCK	I	FS clock input terminal for I/O (1FS)
14	XOVF	O	Adder/subtracter overflow detection output. "L" at overflow time.
15	A6	O	External DRAM address output A6
16	A3	O	External DRAM address output A3
17	A4	O	External DRAM address output A4
18	A5	O	External DRAM address output A5
19	A7	O	External DRAM address output A7
20	XCLR	I	Test pin. Normally, fix at +5V.
21	VDD	—	+5V power supply terminal.
22	A1	O	External DRAM address output A1
23	A2	O	External DRAM address output A2
24	A0	O	External DRAM address output A0
25	XRAS	O	Low address • strobe output terminal for external DRAM.
26	XWSO	O	Serves as a serial data output terminal when DYSL is at "L", and works in accordance with each serial I/O mode. Serves as an external DRAM write enable output terminal when DYSL is at "H".
27	DIO	I/O	Serves as a serial data input terminal when DYSL is at "L", and fetches in data ds accordance with each serial I/O mode. When DYSL is at "H", it serves as an external DRAM data input/output terminal to be used as a common line for data input D_{IN} and data output D_{OUT} .
28	XCAS	O	Column address strobe output terminal for external DRAM.

IC318 SBX1646-01

Pin No.	Symbol	I/O	Description
1	LT1	I	Latch1
2	LT2	I	Latch2
3	LT3	I	Latch3
4	LT4	I	Latch4
5	LT6	I	Latch6
6	LT5	I	Latch5
7	SCK	I	SDT serial • clock input terminal to fetches in data at a rise.
8	SDT	I	Serial • data input terminal to receive instructions, coefficients I/O controls transferred from the microcomputer.
9	VDD	—	+5V power supply terminal.
10	SI1	I	1-sampling 2-channel serial data input terminal.
11	GND	—	GND terminal.
12	SO2	O	1-sampling 2-channel serial data output terminal.
13	BCK	I	Serial bit clock input terminal for and so. serial input data is fetched in at rise of this BCK and output data is sent out. (64FS)
14	MCK	I	Master clock input1. The master clock ACK inside the IC is half this frequency. Fix MCK2 at +5V when inputting the master clock from MCK2.
15	LRCK	I	FS clock input terminal for I/O (1FS)
16	LRDT	O	Front L, Rch data out
17	CSDT	O	Center surround data out
18	GND	—	GND terminal
19	XCAS	O	Column address Strobe output terminal for external DRAM.
20	DI05	I/O	Serves as a serial data input terminal when DYSL is at “L” , and fetches in data as accordance with each serial I/O mode. When DYSL is at “H”, it serves as an external DRAM data input/output terminal to be used as a Common line for data input DIN and data output Dout.
21	XWS05	O	Serves as a serial data output terminal when DYSL is at “L”, and works in accordance with each serial I/O mode. Serves as an external DRAM write enable output terminal when DYSL is at “H”.
22	A6	O	External DRAM address output A6
23	XRAS	O	Low address • strobe output terminal for external DRAM.
24	A3	O	External DRAM address output A3
25	A4	O	External DRAM address output A4
26	A0	O	External DRAM address output A0
27	A5	O	External DRAM address output A5
28	A2	O	External DRAM address output A2
29	A7	O	External DRAM address output A7
30	A1	O	External DRAM address output A1

IC203 UPD78238GC

Pin No.	Symbol	I/O	Description	Pin No.	Symbol	I/O	Description
1	P32/ $\overline{\text{SCK}}$	O	CLK FL Tube	41	P42/AD2	O	EQ LED
2	P33/SO/SB0	O	DAT FL Tube	42	P41/AD1	O	SURR LED
3	P34/TO0	O	(A/D Control)	43	P40/AD0	O	MUTE LED
4	P35/TO1	O	LAT FL Tube	44	ASTB		
5	P36/TO2	O	CLR FL Tube	45	V _{SS}		
6	P37/TO3	O		46	MODE		
7	$\overline{\text{RESET}}$			47	P10/PWM0	O	TAPE2 LED
8	V _{DD}			48	P11/PWM1	O	TITLE
9	X2			49	P12	O	ON. SCR LED
10	X1			50	P13	O	DRLC LED
11	V _{SS}			51	P14	O	
12	PO0	O	Key matrix output	52	P15	O	
13	PO1	O	Key matrix output	53	P16SEL2	O	1 A/D Control
14	PO2	O	Key matrix output	54	P17SEL1	O	2 A/D Control
15	PO3	O	Key matrix output	55	V _{DD}		
16	PO4	O	Key matrix output	56	P70/AN10	I	AN \emptyset
17	PO5	O	Key matrix output	57	P71/AN11	I	AN 1
18	PO6	O	Key matrix output	58	P72/AN12	I	AN 2
19	PO7	O	Key matrix output	59	P73/AN13	I	AN 3
20	P67/ $\overline{\text{REFRQ}}$	O		60	P74AN14	I	AN 4
21	P66/ $\overline{\text{WAIT}}$	I/O	DAT μ -con interface	61	P75/AN15	I	AN 5
22	P65/ $\overline{\text{WR}}$	O	CLK μ -con interface	62	P76/AN16	I	AN 6
23	P64/ $\overline{\text{RD}}$	I	CTS μ -con interface	63	P77/AN17	I	AN 7
24	P63/A19	O	MRQ μ -con interface	64	AV _{DD}		
25	P62/A18	O		65	AV _{REF1}		
26	P61/A17	O		66	AV _{SS}		
27	P60/A16	O	Diode output	67	ANO0		
28	P57/A15	I	Key matrix input	68	ANO1		
29	P56/A14	I	Key matrix input	69	AV _{REF2}		
30	P55/A13	I	Key matrix input	70	AV _{REF3}		
31	P54/A12	I	Key matrix input	71	P20/NM1	I	(NMI)
32	P53/A11	I	Key matrix input	72	P21/INTP0	I	STOP(INTP \emptyset)
33	P52/A12	I	Key matrix input	73	P22/INTP1	I	SIRCS 1
34	P51/A9	I	Key matrix input	74	P23/INTP2/C1	I	SIRS 2
35	P50/A8	O		75	P24/INTP3	I	S. POW key
36	P47/AD7	O	FS48K LED	76	P25/INTP4/ASCK	I	MUTE key
37	P46/AD6	O	FS44K LED	77	P26/INTP5	I	DDS key
38	P45/AD5	O	FS32K LED	78	P27/SI	I	(SI)
39	P44/AD4	O	INDEX LED	79	P30/RxD	I	RxD
40	P43/AD3	O	DDS LED	80	P31/TxD	O	TxD

SECTION 4 EXPLODED VIEWS

NOTE:

- -XX, -X mean standardized parts, so they may have some differences from the original one.
- The construction parts of an assembled part are indicated with a collation number in the remark column.
- Color indication of Appearance Parts
Example:
KNOB, BALANCE (WHITE)....(RED)

↑
↑
 Parts color Cabinet's color

D2:STR-D2070X
D3:STR-D3070X

4-1. FRONT PANEL SECTION

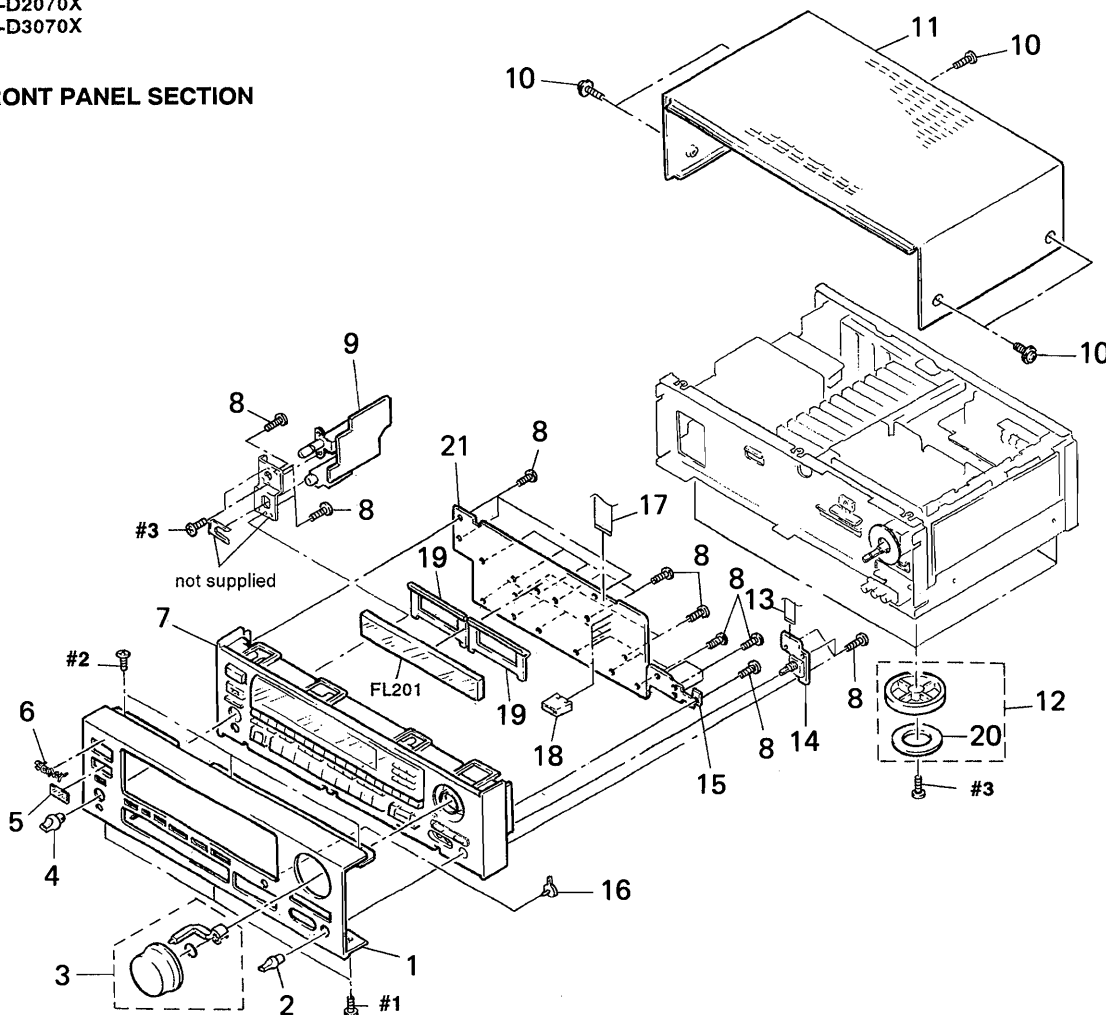

The components identified by mark or dotted line with mark are critical for safety. Replace only with part number specified.

Les composants identifiés par une marque sont critiques pour la sécurité. Ne les remplacer que par une pièce portant le numéro spécifié.

- Items marked "*" are not stocked since they are seldom required for routine service. Some delay should be anticipated when ordering these items.
- The mechanical parts with no reference number in the exploded views are not supplied.
- Hardware (# mark) list is given in the last of this parts list.

Ref.No.	Part No.	Description	Remark	Ref.No.	Part No.	Description	Remark
1	4-947-328-01	PANEL, FRONT (D3)		12	X-4885-950-1	FOOT ASSY	
1	4-947-328-11	PANEL, FRONT (D2)		13	1-575-968-11	WIRE, FLAT TYPE (7 CORE)	
2	4-925-014-01	KNOB (DIA.10)		14	* 1-642-245-11	BALANCE VOLUME BOARD	
3	X-4941-650-1	KNOB (A) ASSY		15	* 1-641-892-11	KEY BOARD	
4	4-908-097-21	KNOB		16	4-938-518-01	INDICATOR (C)	
5	4-947-366-01	FILTER (R)		17	1-690-091-11	WIRE, FLAT TYPE (21 CORE)	
6	4-908-848-01	EMBLEM, SONY		18	* 4-945-958-01	COVER, LAMP	
7	X-4941-912-1	PANEL (BASE) ASSY(D3)		19	4-938-529-01	HOLDER, FL TUBE	
7	X-4941-913-1	PANEL (BASE) ASSY(D2)		20	4-923-836-11	CUSHION	
8	4-928-635-01	SCREW, +BV (2.6X8) TAPPING		21	* A-4345-775-A	DISPLAY BOARD, COMPLETE(D3)	
9	* 1-641-876-11	SPEAKER SWITCH BOARD		21	* A-4347-298-A	DISPLAY BOARD, COMPLETE(D2)	
10	3-704-366-01	SCREW (CASE) (M3X8)		FL201	1-519-683-11	INDICATOR TUBE, FLUORESCENT	
11	4-931-031-11	CASE					

4-2. CHASSIS SECTION-1

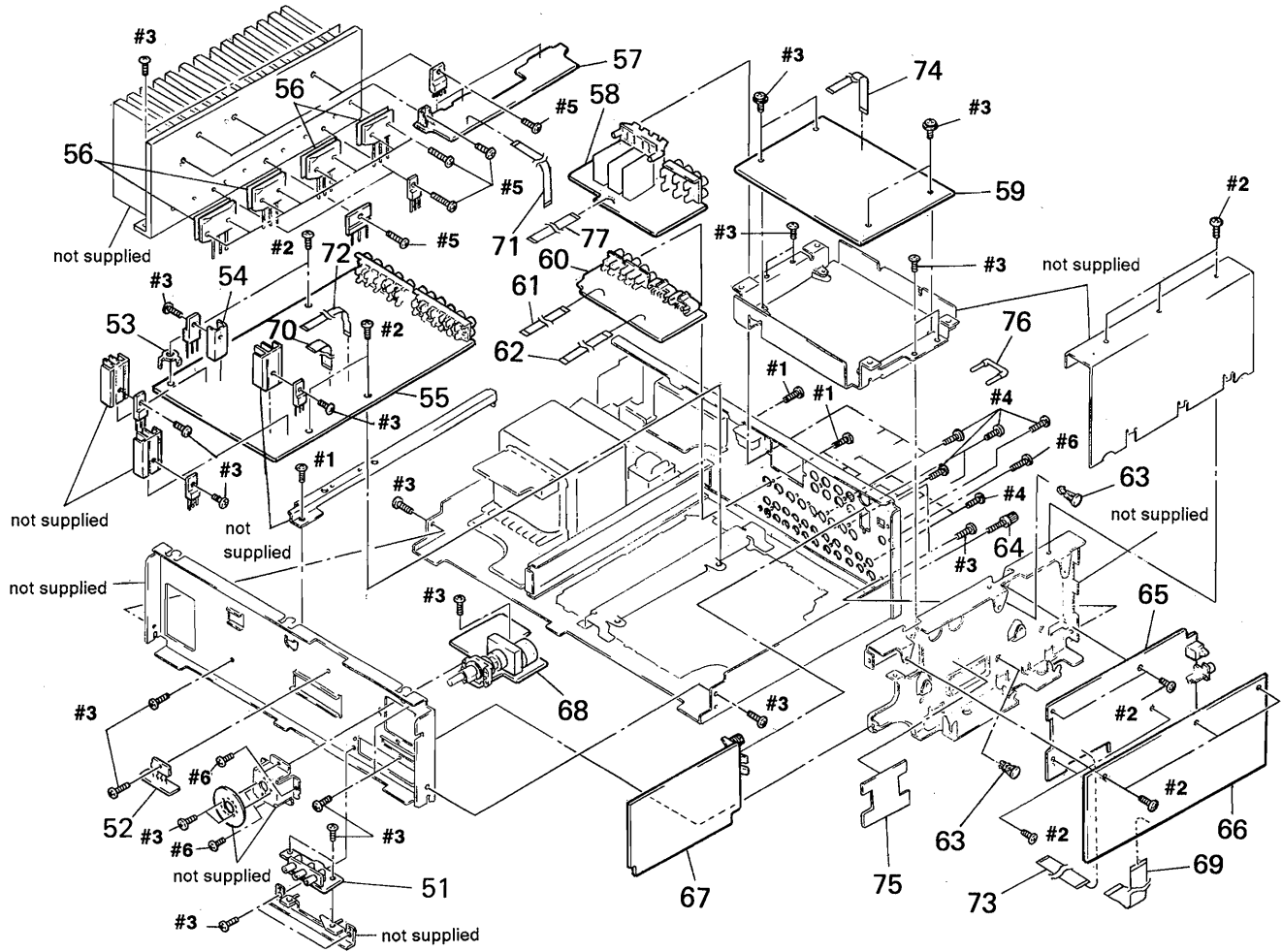

Ref.No.	Part No.	Description	Remark
51	* 1-641-891-11	VIDEO (3) BOARD	
52	* 1-641-879-11	REGULATOR BOARD	
53	* 3-346-266-12	PLATE, GROUND	
54	* 3-309-144-21	HEAT SINK	
55	* A-4345-765-A	MAIN BOARD, COMPLETE (D3/D2:Canadian)	
55	* A-4345-768-A	MAIN BOARD, COMPLETE (D3:US, D2:US, E2, E3)	
56	4-885-901-31	SHEET, RADIATION	
57	* A-4345-769-A	SURROUND POWER BOARD, COMPLETE	
58	* A-4345-783-A	SURROUND SP TM BOARD, COMPLETE	
59	* A-4345-786-A	ON SCREEN BOARD, COMPLETE (D3)	
60	* A-4345-785-A	VIDEO BOARD, COMPLETE (D3)	
61	1-590-031-11	WIRE, FLAT TYPE (5 CORE)	
62	1-590-240-11	WIRE, FLAT TYPE (7 CORE)	
63	* 4-912-181-11	SUPPORT, PC	
64	3-706-165-00	SCREW	

Ref.No.	Part No.	Description	Remark
65	* A-4345-779-A	DIGITAL (1) BOARD, COMPLETE	
66	* A-4345-780-A	DIGITAL (2) BOARD, COMPLETE	
67	* A-4345-777-A	TUNER BOARD, COMPLETE	
68	* A-4345-781-A	MOTOR VOLUME BOARD, COMPLETE	
69	1-590-036-11	WIRE, FLAT TYPE (13 CORE)	
70	* 1-590-241-11	WIRE, FLAT TYPE (11 CORE)	
71	1-690-421-11	WIRE, FLAT TYPE (7 CORE)	
72	1-690-420-21	WIRE, FLAT TYPE (7 CORE)	
73	1-690-422-11	WIRE, FLAT TYPE (19 CORE)	
74	1-690-635-11	WIRE, FLAT TYPE (7 CORE) (D3)	
75	* 4-948-016-01	SPACER (A)	
76	1-535-706-11	PLUG, JUMPER	
77	1-534-517-00	WIRE, FLAT TYPE (11 CORE)	

4-3. CHASSIS SECTION-2

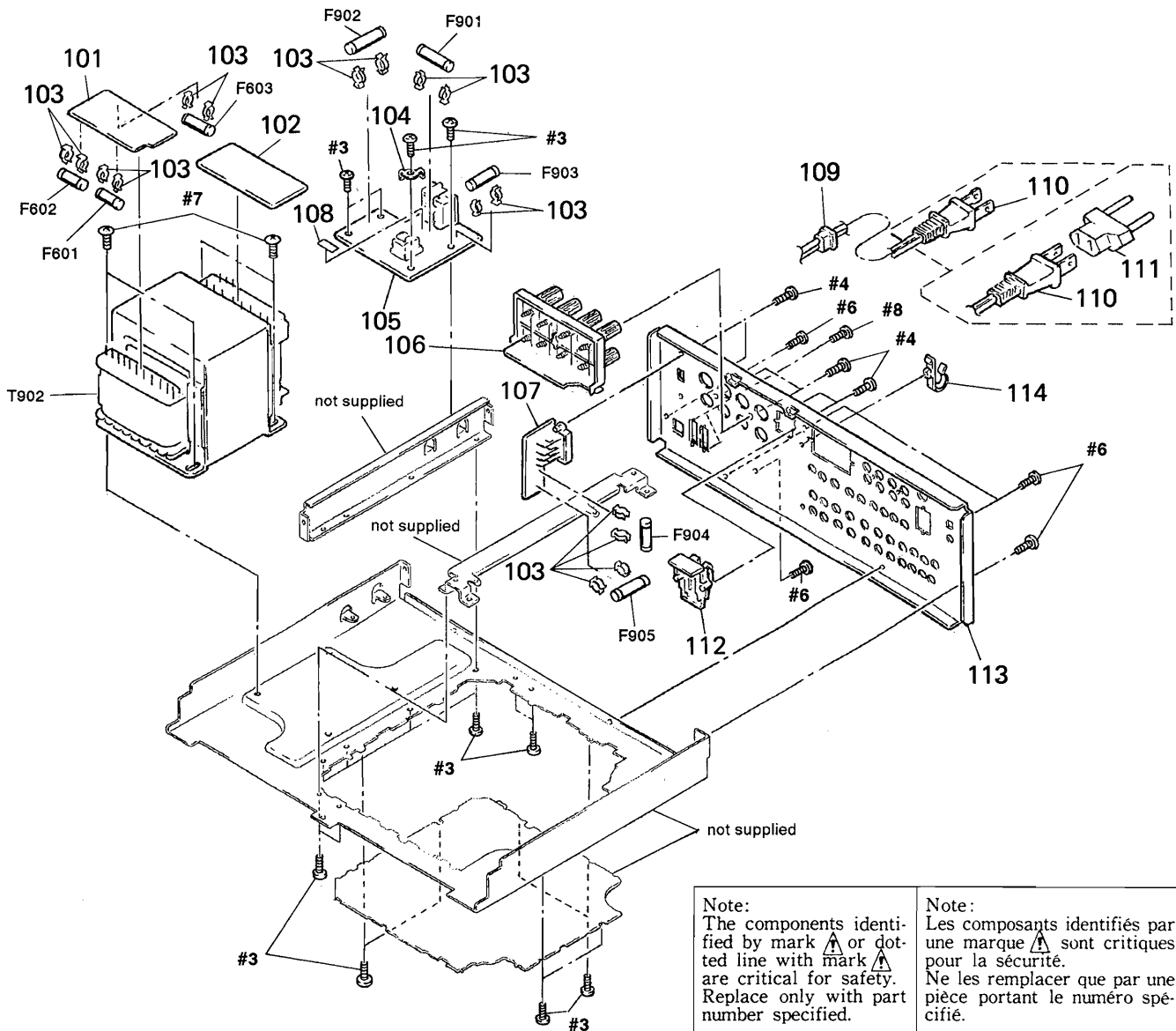

Ref. No.	Part No.	Description	Remark
101	* 1-641-875-11	TRANSFORMER TERMINAL1 BOARD	
102	* 1-641-881-11	TRANSFORMER TERMINAL2 BOARD (D3/D2:US, Canadian)	
102	* 1-641-885-11	TRANSFORMER TERMINAL2 BOARD (D2:E2, E3)	
103	* 1-533-213-31	HOLDER, FUSE	
104	* 3-346-266-12	PLATE, GROUND	
105	* A-4345-778-A	POWER SUPPLY BOARD, COMPLETE (D3/D2:US, Canadian)	
105	* A-4347-028-A	POWER SUPPLY BOARD, COMPLETE (D2:E2, E3)	
106	* 1-641-877-11	MAIN SPEAKER TERMINAL BOARD	
107	* 1-641-878-11	VOLTAGE SELECTION BOARD (D2:E2, E3)	
108	3-701-947-18	LABEL (T4A), FUSE (D2:E2, E3)	
109	* 3-703-244-00	BUSHING (2104), CORD	
110	△ 1-575-975-11	CORD, POWER (D3/D2:US, Canadian)	
110	△ 1-590-074-11	CORD, POWER (D2:E2, E3)	
111	△ 1-569-007-11	ADAPTER, CONVERSION 2P (D2:E2/E3)	
112	* 1-641-889-11	CENTER SP. TM BOARD	

Ref. No.	Part No.	Description	Remark
113	* 4-947-324-01	PANEL, BACK (D3:US)	
113	* 4-947-324-11	PANEL, BACK (D3:Canadian)	
113	* 4-947-324-21	PANEL, BACK (D2:US)	
113	* 4-947-324-31	PANEL, BACK (D2:Canadian)	
113	* 4-947-324-41	PANEL, BACK (D2:E2, E3)	
114	* 4-949-235-01	HOOK	
F601	△ 1-576-109-11	FUSE 5A	
F602	△ 1-576-109-11	FUSE 5A	
F603	△ 1-576-108-11	FUSE 4A	
F901	△ 1-532-350-00	FUSE, TIME-LAG (D2:E2/E3) 4A	
F901	△ 1-576-108-11	FUSE (D2/D3:US, Canadian) 4A	
F902	△ 1-532-749-11	FUSE, GLASS TUBE (D3/D2:US, Canadian) 8A	
F903	△ 1-532-350-00	FUSE, TIME-LAG (D2:E2/E3) 4A	
F904	△ 1-532-350-00	FUSE, TIME-LAG (D2:E2/E3) 4A	
F905	△ 1-532-350-00	FUSE, TIME-LAG (D2:E2/E3) 4A	
T902	△ 1-450-692-11	TRANSFORMER, POWER (D3/D2:US, Canadian)	
T902	△ 1-450-780-11	TRANSFORMER, POWER (D2:E2/E3)	

SECTION 5
ELECTRICAL PARTS LIST

MAIN

SURROUND

TRANSFORMER(1)

SPEAKER

MAIN SPEAKER

VOLTAGE SELECTION

REGULATOR

CENTER SP

NOTE:

- Due to standardization, replacements in the parts list may be different from the parts specified in the diagrams or the components used on the set.
- -XX, -X mean standardized parts, so they may have some difference from the original one.
- RESISTORS
All resistors are in ohms
METAL: Metal-film resistor
METAL OXIDE: Metal oxide-film resistor
F: nonflammable

- Items marked "*" are not stocked since they are seldom required for routine service. Some delay should be anticipated when ordering these items.
- SEMICONDUCTORS
In each case, u: μ , for example:
uA.....: μ A....., uPA.....: μ PA.....
uPB.....: μ PB....., uPC.....: μ PC.....
uPD.....: μ PD.....
- CAPACITORS
uF: μ F
- COILS
uH: μ H

The components identified by mark Δ or dotted line with mark Δ are critical for safety. Replace only with part number specified.

Les composants identifiés par une marque Δ sont critiques pour la sécurité. Ne les remplacer que par une pièce portant le numéro spécifié.

When indicating parts by reference number, please include the board.

D2:STR-D2070X
D3:STR-D3070X

Ref.No.	Part No.	Description	Remark
*	A-4345-765-A	MAIN BOARD, COMPLETE (D3/D2:Canadian) *****	
*	A-4345-768-A	MAIN BOARD, COMPLETE ***** (D3:US, D2:US, E2, E3)	
*	A-4345-769-A	SURROUND POWER BOARD, COMPLETE *****	
*	1-641-875-11	TRANSFORMER TERMINAL1 BOARD *****	
*	1-641-876-11	SPEAKER SWITCH BOARD *****	
*	1-641-877-11	MAIN SPEAKER TERMINAL BOARD *****	
*	1-641-878-11	VOLTAGE SELECTION BOARD (D2:E2, E3) *****	
*	1-641-879-11	REGULATOR BOARD *****	
*	1-641-889-11	CENTER SP. TM BOARD *****	
		* 1-533-213-31 HOLDER, FUSE	
		* 3-309-144-21 HEAT SINK	
		* 3-346-266-12 PLATE, GROUND	
		7-682-548-04 SCREW +BVT 3X8 (S)	
		< BASE POST >	
BP904	* 1-535-140-00	BASE POST 22MM (10MM PITCH) 3P (D2:E2, E3)	
		< CAPACITOR >	
C239	1-124-907-11	ELECT 10uF 20% 50V	
C289	1-124-907-11	ELECT 10uF 20% 50V	
C371	1-162-294-31	CERAMIC 0.001uF 10% 50V	
C601	1-162-282-31	CERAMIC 100PF 10% 50V	
C602	1-124-907-11	ELECT 10uF 20% 50V	

Ref.No.	Part No.	Description	Remark
C603	1-124-910-11	ELECT 47uF 20% 50V	
C604	1-130-480-00	MYLAR 0.0056uF 5% 50V	
C605	1-106-347-00	MYLAR 1500PF 5% 200V	
C606	1-124-907-11	ELECT 10uF 20% 50V	
C607	1-124-910-11	ELECT 47uF 20% 50V	
C608	1-124-907-11	ELECT 10uF 20% 50V	
C609	1-126-096-11	ELECT 10uF 20% 35V	
C610	1-124-907-11	ELECT 10uF 20% 50V	
C611	1-124-910-11	ELECT 47uF 20% 50V	
C612	1-124-907-11	ELECT 10uF 20% 50V	
C613	1-162-294-31	CERAMIC 0.001uF 10% 50V	
C614	1-124-907-11	ELECT 10uF 20% 50V	
C615	1-124-907-11	ELECT 10uF 20% 50V	
C616	1-162-294-31	CERAMIC 0.001uF 10% 50V	
C618	1-124-916-11	ELECT 22uF 20% 63V	
C619	1-124-907-11	ELECT 10uF 20% 50V	
C620	1-162-294-31	CERAMIC 0.001uF 10% 50V	
C624	1-124-910-11	ELECT 47uF 20% 50V	
C625	1-102-977-00	CERAMIC 200PF 5% 50V	
C626	1-124-910-11	ELECT 47uF 20% 50V	
C627	1-124-907-11	ELECT 10uF 20% 50V	
C628	1-124-907-11	ELECT 10uF 20% 50V	
C629	1-124-910-11	ELECT 47uF 20% 50V	
C630	1-124-907-11	ELECT 10uF 20% 50V	
C637	1-124-907-11	ELECT 10uF 20% 50V	
C638	1-124-907-11	ELECT 10uF 20% 50V	
C640	1-124-907-11	ELECT 10uF 20% 50V	
C641	1-124-907-11	ELECT 10uF 20% 50V	
C642	1-124-907-11	ELECT 10uF 20% 50V	
C643	1-124-907-11	ELECT 10uF 20% 50V	
C644	1-124-907-11	ELECT 10uF 20% 50V	
C645	1-124-910-11	ELECT 47uF 20% 50V	
C651	1-162-282-31	CERAMIC 100PF 10% 50V	
C652	1-124-907-11	ELECT 10uF 20% 50V	
C653	1-124-910-11	ELECT 47uF 20% 50V	

MAIN

SURROUND

TRANSFORMER(1)

SPEAKER

MAIN SPEAKER

VOLTAGE SELECTION

REGULATOR

CENTER SP

Ref. No.	Part No.	Description	Remark			Ref. No.	Part No.	Description	Remark		
C654	1-130-480-00	MYLAR	0.0056uF	5%	50V	C712	1-136-161-00	FILM	0.047uF	5%	50V
C655	1-106-347-00	MYLAR	1500PF	5%	200V						(D3/D2:Canadian)
C656	1-124-907-11	ELECT	10uF	20%	50V	C713	1-136-161-00	FILM	0.047uF	5%	50V
C657	1-124-910-11	ELECT	47uF	20%	50V						(D3/D2:Canadian)
C658	1-124-907-11	ELECT	10uF	20%	50V	C714	1-124-463-00	ELECT	0.1uF	20%	50V
C659	1-126-096-11	ELECT	10uF	20%	35V	C715	1-124-472-11	ELECT	470uF	20%	10V
C660	1-124-907-11	ELECT	10uF	20%	50V	C716	1-124-931-11	ELECT	47uF	20%	100V
C662	1-124-907-11	ELECT	10uF	20%	50V	C717	1-124-907-11	ELECT	10uF	20%	50V
C663	1-124-907-11	ELECT	10uF	20%	50V	C721	1-106-391-12	MYLAR	0.1uF	5%	200V
C664	1-124-927-11	ELECT	4.7uF	20%	100V	C722	1-106-391-12	MYLAR	0.1uF	5%	200V
C665	1-161-494-00	CERAMIC	0.022uF		25V	C723	1-125-573-11	ELECT(BLOCK)	12000uF	20%	71V
C666	1-161-494-00	CERAMIC	0.022uF		25V	C724	1-125-573-11	ELECT(BLOCK)	12000uF	20%	71V
C668	1-161-494-00	CERAMIC	0.022uF		25V	C725	1-126-955-11	ELECT	4700uF	20%	35V
C670	1-164-159-11	CERAMIC	0.1uF		50V	C726	1-126-955-11	ELECT	4700uF	20%	35V
C675	1-162-210-31	CERAMIC	30PF	5%	50V	C727	1-164-159-11	CERAMIC	0.1uF		50V
C676	1-162-210-31	CERAMIC	30PF	5%	50V	C734	1-124-667-11	ELECT	10uF	20%	100V
C677	1-164-159-11	CERAMIC	0.1uF		50V	C735	1-124-907-11	ELECT	10uF	20%	50V
C678	1-164-159-11	CERAMIC	0.1uF		50V	C736	1-162-282-31	CERAMIC	100PF	10%	50V
C679	1-125-486-11	DOUBLE LAYERS	0.22F		5.5V	C737	1-124-910-11	ELECT	47uF	20%	50V
C680	1-124-465-00	ELECT	0.47uF	20%	50V	C738	1-124-667-11	ELECT	10uF	20%	100V
C681	1-124-910-11	ELECT	47uF	20%	50V	C739	1-124-463-00	ELECT	0.1uF	20%	50V
C682	1-124-910-11	ELECT	47uF	20%	50V	C740	1-136-157-00	FILM	0.022uF	5%	50V
C683	1-124-910-11	ELECT	47uF	20%	50V	C741	1-162-282-31	CERAMIC	100PF	10%	50V
C684	1-126-834-11	ELECT	6800uF	20%	10V	C742	1-124-910-11	ELECT	47uF	20%	50V
C687	1-124-907-11	ELECT	10uF	20%	50V	C743	1-124-667-11	ELECT	10uF	20%	100V
C688	1-124-907-11	ELECT	10uF	20%	50V	C745	1-136-157-00	FILM	0.022uF	5%	50V
C690	1-124-907-11	ELECT	10uF	20%	50V	C751	1-124-907-11	ELECT	10uF	20%	50V
C691	1-124-907-11	ELECT	10uF	20%	50V	C752	1-102-973-00	CERAMIC	100PF	5%	50V
C692	1-124-907-11	ELECT	10uF	20%	50V	C753	1-162-219-31	CERAMIC	68PF	5%	50V
C693	1-124-907-11	ELECT	10uF	20%	50V	C754	1-102-230-00	CERAMIC	4PF	0.25PF	500V
C694	1-124-907-11	ELECT	10uF	20%	50V	C755	1-102-936-00	CERAMIC	3.0PF	±0.25PF	50V
C695	1-124-910-11	ELECT	47uF	20%	50V	C756	1-124-443-00	ELECT	100uF	20%	10V
C696	1-124-910-11	ELECT	47uF	20%	50V	C757	1-124-910-11	ELECT	47uF	20%	50V
C697	1-164-159-11	CERAMIC	0.1uF		50V	C758	1-102-233-00	CERAMIC	33PF	10%	500V
C698	1-164-159-11	CERAMIC	0.1uF		50V	C759	1-102-233-00	CERAMIC	33PF	10%	500V
C699	1-136-177-00	FILM	1uF	5%	50V	C760	1-124-463-00	ELECT	0.1uF	20%	50V
C701	1-124-907-11	ELECT	10uF	20%	50V	C761	1-124-463-00	ELECT	0.1uF	20%	50V
C702	1-102-973-00	CERAMIC	100PF	5%	50V	C762	1-136-157-00	FILM	0.022uF	5%	50V
C703	1-162-219-31	CERAMIC	68PF	5%	50V						(D3:US/D2:US, E2/E3)
C704	1-102-230-00	CERAMIC	4PF	0.25PF	500V	C762	1-136-161-00	FILM	0.047uF	5%	50V
C705	1-102-936-00	CERAMIC	3.0PF	±0.25PF	50V						(D3/D2:Canadian)
C706	1-124-443-00	ELECT	100uF	20%	10V	C763	1-136-161-00	FILM	0.047uF	5%	50V
C707	1-124-910-11	ELECT	47uF	20%	50V						(D3/D2:Canadian)
C708	1-102-233-00	CERAMIC	33PF	10%	500V	C766	1-124-931-11	ELECT	47uF	20%	100V
C709	1-102-233-00	CERAMIC	33PF	10%	500V	C767	1-124-907-11	ELECT	10uF	20%	50V
C710	1-124-463-00	ELECT	0.1uF	20%	50V	C791	1-162-282-31	CERAMIC	100PF	10%	50V
C711	1-124-463-00	ELECT	0.1uF	20%	50V	C792	1-124-910-11	ELECT	47uF	20%	50V
C712	1-136-157-00	FILM	0.022uF	5%	50V	C795	1-136-157-00	FILM	0.022uF	5%	50V

(D3:US/D2:US, E2, E3)

MAIN

SURROUND

TRANSFORMER(1)

SPEAKER

MAIN SPEAKER

VOLTAGE SELECTION

REGULATOR

CENTER SP

Ref.No.	Part No.	Description	Remark
		< FILTER >	
CF601	1-567-797-11	VIBRATOR, CERAMIC	
		< CONNECTOR >	
CNJ601 *	1-565-481-11	CONNECTOR, BOARD TO BOARD 5P	
CNJ602 *	1-568-830-11	SOCKET, CONNECTOR 11P	
CNJ603 *	1-568-826-11	SOCKET, CONNECTOR 7P	
CNJ604 *	1-568-830-11	SOCKET, CONNECTOR 11P	
CNJ605 *	1-568-832-11	SOCKET, CONNECTOR 13P	
CNJ606	1-568-802-11	SOCKET, CONNECTOR 19P	
CNJ607 *	1-568-826-11	SOCKET, CONNECTOR 7P	
CNJ609 *	1-568-826-11	SOCKET, CONNECTOR 7P	
CNJ703 *	1-568-826-11	SOCKET, CONNECTOR 7P (D3)	
CNJ704	1-568-838-11	SOCKET, CONNECTOR 21P	
CNP603 *	1-564-338-61	PIN, CONNECTOR 4P	
CNP604 *	1-564-506-11	PLUG, CONNECTOR 3P	
CNP605 *	1-564-507-11	PLUG, CONNECTOR 4P	
CNP607 *	1-564-506-11	PLUG, CONNECTOR 3P	
CNP608 *	1-564-508-11	PLUG, CONNECTOR 5P	
CNP609 *	1-564-506-11	PLUG, CONNECTOR 3P	
CNP612 *	1-564-519-11	PLUG, CONNECTOR 4P	
CNP613 *	1-564-506-11	PLUG, CONNECTOR 3P	
CNP614 *	1-564-506-11	PLUG, CONNECTOR 3P	
CNP615 *	1-564-338-00	PIN, CONNECTOR 4P	
CNP701 *	1-564-242-00	PIN, CONNECTOR 5P	
CNP702 *	1-564-506-11	PLUG, CONNECTOR 3P	
CNP709 *	1-564-242-00	PIN, CONNECTOR 5P	
CNP710 *	1-564-674-11	PIN, CONNECTOR 8P	
CNP711 *	1-564-674-11	PIN, CONNECTOR 8P	
CNP907 *	1-564-687-11	PIN, CONNECTOR 3P (D2:E2/E3)	
CNP908 *	1-564-687-11	PIN, CONNECTOR 3P (D2:E2/E3)	
		< CIRCUIT BLOCK >	
CP601	△1-102-394-11	CERAMIC 0.01uF	250V
CP701	1-102-394-11	CERAMIC 0.01uF	250V
		< DIODE >	
D603	8-719-912-20	DIODE 1SS120	
D604	8-719-912-20	DIODE 1SS120	
D605	8-719-912-20	DIODE 1SS120	
D606	8-719-912-20	DIODE 1SS120	
D607	8-719-912-20	DIODE 1SS120	
D609	8-719-912-20	DIODE 1SS120	
D610	8-719-002-76	DIODE UZL-36H	
D614	8-719-200-82	DIODE 11ES2	
D615	8-719-912-20	DIODE 1SS120	
D616	8-719-912-20	DIODE 1SS120	

Ref.No.	Part No.	Description	Remark
D617	8-719-025-03	DIODE RBA-402-SL	
D619	8-719-933-33	DIODE HZS6A1L	
D621	8-719-912-20	DIODE 1SS120	
D622	8-719-912-20	DIODE 1SS120	
D623	8-719-912-20	DIODE 1SS120	
D701	8-719-912-20	DIODE 1SS120	
D702	8-719-912-20	DIODE 1SS120	
D703	8-719-912-20	DIODE 1SS120	
D704	8-719-912-20	DIODE 1SS120	
D707	8-719-912-20	DIODE 1SS120	
D708	8-719-912-20	DIODE 1SS120	
D709	8-719-912-20	DIODE 1SS120	
D710	8-719-912-20	DIODE 1SS120	
D713	8-719-912-20	DIODE 1SS120	
D715	8-719-912-20	DIODE 1SS120	
D716	8-719-912-20	DIODE 1SS120	
D718	8-719-912-20	DIODE 1SS120	
D719	8-719-912-20	DIODE 1SS120	
D720	8-719-912-20	DIODE 1SS120	
D721	8-719-302-37	DIODE RBV-602	
D722	8-719-312-09	DIODE RBA-402	
D723	8-719-912-20	DIODE 1SS120	
D740	8-719-912-20	DIODE 1SS120	
D741	8-719-912-20	DIODE 1SS120	
D751	8-719-912-20	DIODE 1SS120	
D752	8-719-912-20	DIODE 1SS120	
D753	8-719-912-20	DIODE 1SS120	
D754	8-719-912-20	DIODE 1SS120	
D757	8-719-912-20	DIODE 1SS120	
D758	8-719-912-20	DIODE 1SS120	
D759	8-719-912-20	DIODE 1SS120	
D760	8-719-912-20	DIODE 1SS120	
D763	8-719-912-20	DIODE 1SS120	
D765	8-719-912-20	DIODE 1SS120	
D766	8-719-912-20	DIODE 1SS120	
D791	8-719-912-20	DIODE 1SS120	
		< FUSE >	
F601	△1-576-109-11	FUSE T5A	
F602	△1-576-109-11	FUSE T5A	
F603	△1-576-108-11	FUSE T4A	
F904	△1-532-350-00	FUSE, TIME-LAG (D2:E2/E3) T4A	
F905	△1-532-350-00	FUSE, TIME-LAG (D2:E2/E3) T4A	
		< IC >	
IC231	8-759-820-62	IC LB1639	
IC601	8-759-711-35	IC NJM4580D	
IC602	8-759-711-35	IC NJM4580D	
IC603	8-759-711-35	IC NJM4580D	

Note:
The components identified by mark △ or dotted line with mark △ are critical for safety. Replace only with part number specified.

Note:
Les composants identifiés par une marque △ sont critiques pour la sécurité. Ne les remplacer que par une pièce portant le numéro spécifié.

MAIN	SURROUND	TRANSFORMER(1)	SPEAKER	MAIN SPEAKER
VOLTAGE SELECTION			REGULATOR	CENTER SP

Ref. No.	Part No.	Description	Remark	Ref. No.	Part No.	Description	Remark
IC604	8-759-711-35	IC NJM4580D		Q708	8-729-141-37	TRANSISTOR 2SA1684-LK	
IC605	8-759-805-14	IC LC7822		Q709	8-729-320-74	TRANSISTOR 2SA1216-OY	
IC606	8-759-805-14	IC LC7822		Q711	8-729-140-82	TRANSISTOR 2SA988-PAFAEA	
IC607	8-759-711-35	IC NJM4580D		Q712	8-729-140-82	TRANSISTOR 2SA988-PAFAEA	
IC608	8-759-805-13	IC LC7821		Q713	8-729-140-84	TRANSISTOR 2SC1841-PAFAEA	
IC609	8-759-710-73	IC NJM4580L		Q714	8-729-620-05	TRANSISTOR 2SC2603-EF	
IC610	8-759-710-73	IC NJM4580L		Q715	8-729-140-82	TRANSISTOR 2SA988-PAFAEA	
IC611	8-759-824-12	IC LC7536		Q716	8-729-620-05	TRANSISTOR 2SC2603-EF	
IC613	8-759-059-13	IC uPD78134GF-040-3B9		Q740	8-729-140-82	TRANSISTOR 2SA988-PAFAEA	
IC616	8-759-604-40	IC M5F78M15-L		Q741	8-729-140-82	TRANSISTOR 2SA988-PAFAEA	
IC617	8-759-604-46	IC M5F79M15-L		Q752	8-729-320-82	TRANSISTOR 2SC2922-OY	
IC618	8-759-924-12	IC LM7805CT		Q754	8-729-141-46	TRANSISTOR 2SC4431-LK	
IC619	8-759-711-35	IC NJM4580D		Q755	8-729-209-15	TRANSISTOR 2SD2012	
IC621	8-759-512-48	IC XR-1092		Q758	8-729-141-37	TRANSISTOR 2SA1684-LK	
IC701	8-749-921-85	IC STK-3122-3		Q759	8-729-320-74	TRANSISTOR 2SA1216-OY	
IC702	8-759-323-30	IC LM3875-2		Q767	8-729-140-82	TRANSISTOR 2SA988-PAFAEA	
IC703	8-759-502-32	IC SI18752N		Q768	8-729-140-82	TRANSISTOR 2SA988-PAFAEA	
IC704	8-759-502-32	IC SI18752N		Q791	8-729-140-82	TRANSISTOR 2SA988-PAFAEA	
< JACK >				< RESISTOR >			
J601	1-691-260-11	JACK, PIN 6P (PHONO/CD/DAT)		R149	1-249-441-11	CARBON 100K 5% 1/4W	
J602	1-691-260-11	JACK, PIN 6P (TAPE 1/DAT)		R159	1-249-441-11	CARBON 100K 5% 1/4W	
J603	1-691-260-11	JACK, PIN 6P (VIDEO 2,LD)		R175	1-249-441-11	CARBON 100K 5% 1/4W	
J604	1-573-520-11	JACK, PIN 4P (TAPE 2)		R176	1-249-441-11	CARBON 100K 5% 1/4W	
J605	1-566-819-31	JACK 1P (DRLC)		R324	1-249-441-11	CARBON 100K 5% 1/4W	
J703	1-573-203-11	JACK, LARGE TYPE (HEADPHONS)		R374	1-249-441-11	CARBON 100K 5% 1/4W	
< COIL >				R600	1-249-407-11	CARBON 150 5% 1/4W	
L601	1-410-521-11	INDUCTOR 100uH		R601	1-249-411-11	CARBON 330 5% 1/4W	
L701	* 1-420-872-00	COIL, AIR CORE		R602	1-249-441-11	CARBON 100K 5% 1/4W	
L751	* 1-420-872-00	COIL, AIR CORE		R603	1-249-441-11	CARBON 100K 5% 1/4W	
< TRANSISTOR >				R604	1-249-417-11	CARBON 1K 5% 1/4W	
Q142	8-729-900-61	TRANSISTOR DTA114ES		R605	1-247-897-11	CARBON 560K 5% 1/4W	
Q601	8-729-620-05	TRANSISTOR 2SC2603-EF		R606	1-249-437-11	CARBON 47K 5% 1/4W	
Q612	8-729-209-15	TRANSISTOR 2SD2012		R607	1-247-903-00	CARBON 1M 5% 1/4W	
Q615	8-729-900-80	TRANSISTOR DTC114ES		R608	1-249-409-11	CARBON 220 5% 1/4W	
Q616	8-729-900-61	TRANSISTOR DTA114ES		R609	1-249-409-11	CARBON 220 5% 1/4W	
Q617	8-729-900-61	TRANSISTOR DTA114ES		R610	1-249-438-11	CARBON 56K 5% 1/4W	
Q618	8-729-900-80	TRANSISTOR DTC114ES		R611	1-249-409-11	CARBON 220 5% 1/4W	
Q619	8-729-900-61	TRANSISTOR DTA114ES		R612	1-249-438-11	CARBON 56K 5% 1/4W	
Q620	8-729-107-84	TRANSISTOR 2SC3623A-L		R613	1-249-417-11	CARBON 1K 5% 1/4W	
Q621	8-729-900-61	TRANSISTOR DTA114ES		R614	1-249-417-11	CARBON 1K 5% 1/4W	
Q622	8-729-620-05	TRANSISTOR 2SC2603-EF		R615	1-249-417-11	CARBON 1K 5% 1/4W	
Q670	8-729-107-84	TRANSISTOR 2SC3623A-L		R618	1-249-426-11	CARBON 5.6K 5% 1/4W	
Q702	8-729-320-82	TRANSISTOR 2SC2922-OY		R619	1-249-423-11	CARBON 3.3K 5% 1/4W	
Q704	8-729-141-46	TRANSISTOR 2SC4431-LK		R620	1-249-441-11	CARBON 100K 5% 1/4W	
Q705	8-729-209-15	TRANSISTOR 2SD2012		R621	1-249-417-11	CARBON 1K 5% 1/4W	
				R622	1-249-405-11	CARBON 100 5% 1/4W	
				R625	1-247-887-00	CARBON 220K 5% 1/4W	
				R626	1-249-397-11	CARBON 22 5% 1/4W	

MAIN

SURROUND

TRANSFORMER(1)

SPEAKER

MAIN SPEAKER

VOLTAGE SELECTION

REGULATOR

CENTER SP

Ref.No.	Part No.	Description	Remark			Ref.No.	Part No.	Description	Remark		
R631	1-249-425-11	CARBON	4.7K	5%	1/4W	R694	1-249-417-11	CARBON	1K	5%	1/4W
R640	△1-215-907-11	METAL OXIDE	22	5%	3W F	R695	1-249-402-11	CARBON	56	5%	1/4W
R641	1-249-429-11	CARBON	10K	5%	1/4W	R696	1-249-417-11	CARBON	1K	5%	1/4W
R642	1-249-429-11	CARBON	10K	5%	1/4W	R697	1-249-417-11	CARBON	1K	5%	1/4W
R643	1-249-429-11	CARBON	10K	5%	1/4W	R698	1-249-417-11	CARBON	1K	5%	1/4W
R644	1-249-417-11	CARBON	1K	5%	1/4W	R699	1-249-441-11	CARBON	100K	5%	1/4W
R645	1-249-426-11	CARBON	5.6K	5%	1/4W	R701	1-249-417-11	CARBON	1K	5%	1/4W
R646	1-249-417-11	CARBON	1K	5%	1/4W	R703	1-249-441-11	CARBON	100K	5%	1/4W
R647	1-249-417-11	CARBON	1K	5%	1/4W	R704	1-249-413-11	CARBON	470	5%	1/4W
R648	1-249-417-11	CARBON	1K	5%	1/4W	R705	1-249-441-11	CARBON	100K	5%	1/4W
R649	1-249-441-11	CARBON	100K	5%	1/4W	R706	1-249-415-11	CARBON	680	5%	1/4W
R650	1-249-429-11	CARBON	10K	5%	1/4W	R707	△1-249-405-11	CARBON	100	5%	1/4W
R651	1-249-411-11	CARBON	330	5%	1/4W	R708	1-249-422-11	CARBON	2.7K	5%	1/4W
R652	1-249-441-11	CARBON	100K	5%	1/4W	R709	1-249-417-11	CARBON	1K	5%	1/4W
R653	1-249-441-11	CARBON	100K	5%	1/4W	R710	△1-249-405-11	CARBON	100	5%	1/4W
R654	1-249-417-11	CARBON	1K	5%	1/4W	R711	1-249-441-11	CARBON	100K	5%	1/4W
R655	1-247-897-11	CARBON	560K	5%	1/4W	R712	1-249-421-11	CARBON	2.2K	5%	1/4W
R656	1-249-437-11	CARBON	47K	5%	1/4W	R713	1-249-409-11	CARBON	220	5%	1/4W
R657	1-247-903-00	CARBON	1M	5%	1/4W	R714	△1-247-739-11	CARBON	100	5%	1/2W
R658	1-249-409-11	CARBON	220	5%	1/4W	R715	△1-247-688-11	CARBON	10	5%	1/4W
R659	1-249-409-11	CARBON	220	5%	1/4W	R716	1-249-441-11	CARBON	100K	5%	1/4W
R660	1-249-438-11	CARBON	56K	5%	1/4W	R717	△1-214-789-00	RES, METAL PLATE	0.1		
R661	1-249-409-11	CARBON	220	5%	1/4W	R718	△1-214-789-00	RES, METAL PLATE	0.1		
R662	1-249-438-11	CARBON	56K	5%	1/4W	R719	△1-247-688-11	CARBON	10	5%	1/4W
R663	1-249-417-11	CARBON	1K	5%	1/4W	R720	1-249-417-11	CARBON	1K	5%	1/4W
R664	1-249-417-11	CARBON	1K	5%	1/4W	R721	1-249-431-11	CARBON	15K	5%	1/4W
R665	1-249-417-11	CARBON	1K	5%	1/4W	R722	△1-217-151-00	RES, METAL PLATE	0.22		
R668	1-249-426-11	CARBON	5.6K	5%	1/4W	R723	1-249-419-11	CARBON	1.5K	5%	1/4W
R670	1-249-441-11	CARBON	100K	5%	1/4W	R724	△1-249-393-11	CARBON	10	5%	1/4W
R671	1-249-417-11	CARBON	1K	5%	1/4W	R725	1-249-417-11	CARBON	1K	5%	1/4W
R672	1-249-405-11	CARBON	100	5%	1/4W	R726	1-249-409-11	CARBON	220	5%	1/4W
R674	1-249-429-11	CARBON	10K	5%	1/4W	R727	1-249-431-11	CARBON	15K	5%	1/4W
R675	1-247-887-00	CARBON	220K	5%	1/4W	R728	1-249-431-11	CARBON	15K	5%	1/4W
R678	1-249-433-11	CARBON	22K	5%	1/4W	R729	1-249-482-11	CARBON	4.7	5%	1/2W
R679	1-249-410-11	CARBON	270	5%	1/4W	R730	1-247-727-11	CARBON	10	5%	1/2W
R680	1-249-427-11	CARBON	6.8K	5%	1/4W	R731	1-249-429-11	CARBON	10K	5%	1/4W
R681	1-249-441-11	CARBON	100K	5%	1/4W	R732	1-249-436-11	CARBON	39K	5%	1/4W
R682	1-249-441-11	CARBON	100K	5%	1/4W	R733	1-249-437-11	CARBON	47K	5%	1/4W
R683	1-249-441-11	CARBON	100K	5%	1/4W	R734	1-249-417-11	CARBON	1K	5%	1/4W
R684	1-249-441-11	CARBON	100K	5%	1/4W	R735	1-249-438-11	CARBON	56K	5%	1/4W
R685	1-249-441-11	CARBON	100K	5%	1/4W	R736	△1-215-869-11	METAL OXIDE	1K	5%	1W F
R686	1-249-441-11	CARBON	100K	5%	1/4W	R737	△1-247-696-11	CARBON	47	5%	1/4W
R687	△1-215-907-11	METAL OXIDE	22	5%	3W F	R741	1-249-441-11	CARBON	100K	5%	1/4W
R688	1-249-393-11	CARBON	10	5%	1/4W	R742	1-249-421-11	CARBON	2.2K	5%	1/4W
R689	1-249-441-11	CARBON	100K	5%	1/4W	R743	1-249-441-11	CARBON	100K	5%	1/4W
R690	1-249-429-11	CARBON	10K	5%	1/4W	R744	1-249-417-11	CARBON	1K	5%	1/4W
R691	1-249-425-11	CARBON	4.7K	5%	1/4W	R745	1-249-431-11	CARBON	15K	5%	1/4W
R692	1-249-393-11	CARBON	10	5%	1/4W	R746	△1-217-151-00	RES, METAL PLATE	0.22		
R693	1-249-425-11	CARBON	4.7K	5%	1/4W	R747	1-249-438-11	CARBON	56K	5%	1/4W

Note:
The components identified by mark △ or dotted line with mark △ are critical for safety. Replace only with part number specified.

Note:
Les composants identifiés par une marque △ sont critiques pour la sécurité. Ne les remplacer que par une pièce portant le numéro spécifié.

MAIN

SURROUND

TRANSFORMER(1)

SPEAKER

MAIN SPEAKER

VOLTAGE SELECTION

REGULATOR

CENTER SP

DISPLAY

TUNER

POWER SUPPLY

TRANSFORMER(2)

Ref.No.	Part No.	Description	Remark		
R748	△1-249-393-11	CARBON	10	5%	1/4W
R751	1-249-417-11	CARBON	1K	5%	1/4W
R753	1-249-441-11	CARBON	100K	5%	1/4W
R754	1-249-413-11	CARBON	470	5%	1/4W
R755	1-249-441-11	CARBON	100K	5%	1/4W
R756	1-249-415-11	CARBON	680	5%	1/4W
R757	△1-249-405-11	CARBON	100	5%	1/4W
R758	1-249-422-11	CARBON	2.7K	5%	1/4W
R759	1-249-417-11	CARBON	1K	5%	1/4W
R760	△1-249-405-11	CARBON	100	5%	1/4W
R761	1-249-438-11	CARBON	56K	5%	1/4W
R764	△1-247-739-11	CARBON	100	5%	1/2W
R765	△1-247-688-11	CARBON	10	5%	1/4W
R767	△1-214-789-00	RES, METAL PLATE		0.1	
R768	△1-214-789-00	RES, METAL PLATE		0.1	
R769	△1-247-688-11	CARBON	10	5%	1/4W
R773	1-249-419-11	CARBON	1.5K	5%	1/4W
R775	1-249-417-11	CARBON	1K	5%	1/4W
R776	1-249-409-11	CARBON	220	5%	1/4W
R777	1-249-431-11	CARBON	15K	5%	1/4W
R778	1-249-431-11	CARBON	15K	5%	1/4W
R779	1-249-482-11	CARBON	4.7	5%	1/2W
R780	1-247-727-11	CARBON	10	5%	1/2W
R781	1-249-441-11	CARBON	100K	5%	1/4W
R782	1-249-441-11	CARBON	100K	5%	1/4W
R783	1-247-704-11	CARBON	220	5%	1/4W
R785	1-249-437-11	CARBON	47K	5%	1/4W
R786	△1-215-869-11	METAL OXIDE	1K	5%	1W F
R787	△1-247-696-11	CARBON	47	5%	1/4W
R791	1-249-441-11	CARBON	100K	5%	1/4W
R792	1-249-421-11	CARBON	2.2K	5%	1/4W
R793	1-249-441-11	CARBON	100K	5%	1/4W
R794	1-249-417-11	CARBON	1K	5%	1/4W
R795	1-249-431-11	CARBON	15K	5%	1/4W
R796	△1-217-151-00	RES, METAL PLATE		0.22	
R797	1-249-437-11	CARBON	47K	5%	1/4W
R798	△1-249-393-11	CARBON	10	5%	1/4W
R867	1-249-429-11	CARBON	10K	5%	1/4W
R868	1-249-429-11	CARBON	10K	5%	1/4W
R869	1-249-429-11	CARBON	10K	5%	1/4W
R875	1-249-441-11	CARBON	100K	5%	1/4W
R876	1-249-441-11	CARBON	100K	5%	1/4W
R877	1-249-441-11	CARBON	100K	5%	1/4W
R878	1-249-441-11	CARBON	100K	5%	1/4W
R881	1-249-441-11	CARBON	100K	5%	1/4W
R882	1-249-441-11	CARBON	100K	5%	1/4W
R883	1-249-441-11	CARBON	100K	5%	1/4W
R884	1-249-441-11	CARBON	100K	5%	1/4W
R885	1-249-441-11	CARBON	100K	5%	1/4W

Ref.No.	Part No.	Description	Remark		
R886	1-249-441-11	CARBON	100K	5%	1/4W
R6001	1-249-409-11	CARBON	220	5%	1/4W
R6002	1-249-438-11	CARBON	56K	5%	1/4W
R6003	1-249-429-11	CARBON	10K	5%	1/4W
R6051	1-249-409-11	CARBON	220	5%	1/4W
R6052	1-249-438-11	CARBON	56K	5%	1/4W
< VARIABLE RESISTOR >					
RT701	1-238-597-11	RES, ADJ, CARBON 1K	(BIAS)		
RT751	1-238-597-11	RES, ADJ, CARBON 1K	(BIAS)		
< RELAY >					
RY601	1-515-726-11	RELAY			
RY701	1-515-356-00	RELAY			
< SWITCH >					
S701	1-572-911-11	SWITCH, ROTARY SLIDE	(SPEAKERS)		
< TERMINAL >					
TM701	1-537-235-11	TERMINAL BOARD (SP)	(FRONT SPEAKER)		
TM703	* 1-537-240-21	TERMINAL BOARD (CHECKER PIN)	(CENTER SPEAKER)		
< CONNECTOR >					
TP701	* 1-560-062-00	PIN, CONNECTOR	4P		
< VOLTAGE SWITCH >					
VS901	△1-571-437-11	SWITCH, POWER VOLTAGE CHANGE	(D2:E2, E3)		

* A-4345-775-A DISPLAY BOARD, COMPLETE(D3)					

* A-4347-298-A DISPLAY BOARD, COMPLETE(D2)					

* A-4345-777-A TUNER BOARD, COMPLETE					

* A-4345-778-A POWER SUPPLY BOARD, COMPLETE					

(included MOTOR VOLUME BOARD)					
(D3/D2:US, Canadian)					
* A-4347-028-A POWER SUPPLY BOARD, COMPLETE (D2:E2, E3)					

* 1-641-881-11 TRANSFORMER TERMINAL2 BOARD					

(D3/D2:US, Canadian)					
* 1-641-885-11 TRANSFORMER TERMINAL2 BOARD (D2:E2, E3)					

Note:
The components identified by mark △ or dotted line with mark △ are critical for safety. Replace only with part number specified.

Note:
Les composants identifiés par une marque △ sont critiques pour la sécurité. Ne les remplacer que par une pièce portant le numéro spécifié.

DISPLAY

TUNER

POWER SUPPLY

TRANSFORMER(2)

Ref.No.	Part No.	Description	Remark
	* 1-533-213-31	HOLDER, FUSE	
	* 3-309-144-21	HEAT SINK	
	* 3-346-266-12	PLATE, GROUND	
	4-938-529-01	HOLDER, FL TUBE	
	* 4-945-958-01	COVER, LAMP	
	7-682-548-04	SCREW +BVTT 3X8 (S)	
	< BASE POST >		
BP901	* 1-535-140-00	BASE POST 22MM (10MM PITCH) 3P	(D2:E2, E3)
BP902	* 1-535-140-00	BASE POST 22MM (10MM PITCH) 3P	(D2:E2, E3)
BP903	1-535-139-00	BASE POST 22MM (10MM PITCH) 2P	
	< CAPACITOR >		
C001	1-164-159-11	CERAMIC 0.1uF	50V
C002	1-124-907-11	ELECT 10uF	20% 50V
C003	1-164-159-11	CERAMIC 0.1uF	50V
C005	1-164-159-11	CERAMIC 0.1uF	50V
C006	1-124-477-11	ELECT 47uF	20% 25V
C011	1-164-159-11	CERAMIC 0.1uF	50V
C012	1-164-159-11	CERAMIC 0.1uF	50V
C013	1-164-159-11	CERAMIC 0.1uF	50V
C014	1-124-477-11	ELECT 47uF	20% 25V
C015	1-161-379-00	CERAMIC 0.01uF	20% 25V
C016	1-124-903-11	ELECT 1uF	20% 50V
C017	1-162-211-31	CERAMIC 33PF	5% 50V
C021	1-161-379-00	CERAMIC 0.01uF	20% 25V
C024	1-164-159-11	CERAMIC 0.1uF	50V
C025	1-124-907-11	ELECT 10uF	20% 50V
C026	1-124-927-11	ELECT 4.7uF	20% 100V
C027	1-124-927-11	ELECT 4.7uF	20% 100V
C028	1-164-159-11	CERAMIC 0.1uF	50V
C030	1-124-927-11	ELECT 4.7uF	20% 100V
C031	1-136-161-00	FILM 0.047uF	5% 50V
C032	1-164-159-11	CERAMIC 0.1uF	50V
C033	1-136-155-00	FILM 0.015uF	5% 50V
C034	1-124-907-11	ELECT 10uF	20% 50V
C035	1-162-288-31	CERAMIC 330PF	10% 50V
C036	1-136-161-00	FILM 0.047uF	5% 50V
C037	1-124-907-11	ELECT 10uF	20% 50V
C038	1-130-468-00	MYLAR 560PF	5% 50V
C039	1-130-468-00	MYLAR 560PF	5% 50V
C040	1-124-903-11	ELECT 1uF	20% 50V
C041	1-124-907-11	ELECT 10uF	20% 50V
C042	1-124-907-11	ELECT. 10uF	20% 50V
C044	1-124-477-11	ELECT 47uF	20% 25V
C045	1-124-902-00	ELECT 0.47uF	20% 50V
C046	1-124-903-11	ELECT 1uF	20% 50V

Ref.No.	Part No.	Description	Remark
C047	1-124-903-11	ELECT 1uF	20% 50V
C048	1-124-903-11	ELECT 1uF	20% 50V
C051	1-164-159-11	CERAMIC 0.1uF	50V
C052	1-161-379-00	CERAMIC 0.01uF	20% 25V
C053	1-124-925-11	ELECT 2.2uF	20% 100V
C054	1-124-907-11	ELECT 10uF	20% 50V
C055	1-164-159-11	CERAMIC 0.1uF	50V
C056	1-161-379-00	CERAMIC 0.01uF	20% 25V
C057	1-162-207-31	CERAMIC 22PF	5% 50V
C058	1-124-907-11	ELECT 10uF	20% 50V
C059	1-161-379-00	CERAMIC 0.01uF	20% 25V
C060	1-164-159-11	CERAMIC 0.1uF	50V
C061	1-162-206-31	CERAMIC 20PF	5% 50V
C062	1-162-206-31	CERAMIC 20PF	5% 50V
C201	1-164-159-11	CERAMIC 0.1uF	50V
C202	1-124-477-11	ELECT 47uF	20% 25V
C203	1-164-159-11	CERAMIC 0.1uF	50V
C204	1-124-907-11	ELECT 10uF	20% 50V
C208	1-164-159-11	CERAMIC 0.1uF	50V
C209	1-162-210-31	CERAMIC 30PF	5% 50V
C210	1-162-210-31	CERAMIC 30PF	5% 50V
C212	1-164-159-11	CERAMIC 0.1uF	50V
C213	1-161-494-00	CERAMIC 0.022uF	25V
C214	1-161-494-00	CERAMIC 0.022uF	25V
C215	1-161-494-00	CERAMIC 0.022uF	25V
C216	1-164-159-11	CERAMIC 0.1uF	50V
C218	1-164-159-11	CERAMIC 0.1uF	50V
C219	1-164-159-11	CERAMIC 0.1uF	50V
C220	1-164-159-11	CERAMIC 0.1uF	50V
C240	1-124-907-11	ELECT 10uF	20% 50V
C241	1-124-907-11	ELECT 10uF	20% 50V
C242	1-124-903-11	ELECT 1uF	20% 50V
C243	1-124-903-11	ELECT 1uF	20% 50V
C244	1-164-159-11	CERAMIC 0.1uF	50V
C245	1-124-907-11	ELECT 10uF	20% 50V
C246	1-124-477-11	ELECT 47uF	20% 25V
C290	1-124-907-11	ELECT 10uF	20% 50V
C804	1-124-557-11	ELECT 1000uF	20% 25V
C805	1-124-477-11	ELECT 47uF	20% 25V
C806	1-124-903-11	ELECT 1uF	20% 50V
C807	1-124-907-11	ELECT 10uF	20% 50V
C808	1-124-464-11	ELECT 0.22uF	20% 50V
C809	1-106-367-00	MYLAR 0.01uF	5% 200V
C810	1-106-367-00	MYLAR 0.01uF	5% 200V
C901	1-161-744-00	CERAMIC 0.01uF	400V
	< FILTER >		
CF001	1-567-393-11	FILTER, CERAMIC	
CF002	1-567-393-11	FILTER, CERAMIC	

DISPLAY

TUNER

POWER SUPPLY

TRANSFORMER(2)

Ref.No.	Part No.	Description	Remark
CF003	1-567-250-11	OSCILLATOR, CERAMIC	
CF004	1-527-981-00	FILTER, CERAMIC	
CF201	1-567-797-11	VIBRATOR, CERAMIC	
CFT001	1-404-713-11	TRANSFORMER, IF	
< CONNECTOR >			
CNJ001 *	1-568-830-11	SOCKET, CONNECTOR 11P	
CNJ201 *	1-568-864-11	SOCKET, CONNECTOR 21P	
CNJ202 *	1-565-480-11	CONNECTOR, BOARD TO BOARD 4P	
CNJ240 *	1-568-826-11	SOCKET, CONNECTOR 7P	
CNJ241 *	1-568-826-11	SOCKET, CONNECTOR 7P	
CNJ242 *	1-568-824-11	SOCKET, CONNECTOR 5P	
CNJ901	1-540-060-11	OUTLET, AC (POLAR)	
CNP201 *	1-564-496-11	PIN, CONNECTOR 3P	
CNP240 *	1-564-507-11	PLUG, CONNECTOR 4P	
CNP241 *	1-564-506-11	PLUG, CONNECTOR 3P	
CNP242 *	1-564-505-11	PLUG, CONNECTOR 2P	
CNP801 *	1-564-338-61	PIN, CONNECTOR 4P	
CNP903 *	1-564-321-00	PIN, CONNECTOR 2P	
CNP904 *	1-564-496-11	PIN, CONNECTOR 3P	
CNP905 *	1-564-687-11	PIN, CONNECTOR 3P (D2:E2, E3)	
CNP906 *	1-564-687-11	PIN, CONNECTOR 3P (D2:E2, E3)	
< DIODE >			
D001	8-719-912-20	DIODE 1SS120	
D002	8-719-912-20	DIODE 1SS120	
D003	8-719-301-38	LED SEL2210S-C	
D004	8-719-912-20	DIODE 1SS120	
D201	8-719-912-20	DIODE 1SS120	
D202	8-719-912-20	DIODE 1SS120	
D203	8-719-301-56	DIODE SEL2813A-D (SURR)	
D204	8-719-301-56	DIODE SEL2813A-D (EQ)	
D205	8-719-301-56	DIODE SEL2813A-D (DDS)	
D206	8-719-301-56	DIODE SEL2813A-D (INDEX)	
D207	8-719-313-72	LED SEL3810A (48)	
D208	8-719-313-72	LED SEL3810A (44.1)	
D209	8-719-313-72	LED SEL3810A (32)	
D210	8-719-313-72	LED SEL3810A (D3) (TITLE ON)	
D211	8-719-313-72	LED SEL3810A (D3) (ON SCREEN)	
D213	8-719-301-49	LED SEL2810A (MONITOR)	
D214	8-719-301-52	LED SEL2810A-C (DRLC/POWER)	
D215	8-719-301-52	LED SEL2810A-C (DRLC/POWER)	
D219	8-719-912-20	DIODE 1SS120	
D221	8-719-912-20	DIODE 1SS120	
D222	8-719-014-82	DIODE UZP-6.8B	
D223	8-719-912-20	DIODE 1SS120	
D240	8-719-912-20	DIODE 1SS120	
D241	8-719-912-20	DIODE 1SS120	
D802	8-719-912-20	DIODE 1SS120	

Ref.No.	Part No.	Description	Remark
D807	8-719-000-06	DIODE MC921	
D808	8-719-933-41	DIODE HZS6C3L	
D809	8-719-933-41	DIODE HZS6C3L	
D810	8-719-914-11	DIODE HZ4ALL	
D815	8-719-200-82	DIODE 11ES2	
D816	8-719-200-82	DIODE 11ES2	
D817	8-719-200-82	DIODE 11ES2	
D818	8-719-200-82	DIODE 11ES2	
< FUSE >			
F901	△1-532-350-00	FUSE, TIME-LAG (D2:E2/E3) T4A	
F901	△1-576-108-11	FUSE (D2/D3:US, Canadian) T4A	
F902	△1-532-749-11	FUSE, GLASS TUBE (D3/D2:US, Canadian) T8A	
F903	△1-532-350-00	FUSE, TIME-LAG (D2:E2/E3) T4A	
< FRONT END >			
FE001	1-463-862-21	FRONT END, FM	
FE002	1-236-461-11	ENCAPSULATED COMPONENT	
< FILTER >			
FL201	1-519-683-11	INDICATOR TUBE, FLUORESCENT	
< IC >			
IC001	8-759-804-55	IC LA1266	
IC002	8-759-801-80	IC LA3401	
IC003	8-759-820-91	IC LC7218	
IC201	8-759-990-38	IC MSC1162GS	
IC202	8-759-990-38	IC MSC1162GS	
IC203	8-759-047-58	IC uPD78238GC-205-3B9	
IC204	8-749-922-36	IC GP1U50XB	
IC240	8-759-710-73	IC NJM4580L	
IC241	8-759-634-51	IC M5218AP	
< COIL >			
L001	1-410-509-11	INDUCTOR 10uH	
L002	1-410-171-11	INDUCTOR 1mH	
L003	1-410-509-11	INDUCTOR 10uH	
< FILTER >			
LPF001	1-235-164-00	FILTER, LOW PASS	
LPF002	1-235-164-00	FILTER, LOW PASS	
< TRANSISTOR >			
Q001	8-729-620-19	TRANSISTOR 2SC2724-CD	
Q002	8-729-620-19	TRANSISTOR 2SC2724-CD	
Q003	8-729-900-61	TRANSISTOR DTA114ES	
Q004	8-729-620-05	TRANSISTOR 2SC2603-EF	
Q005	8-729-900-80	TRANSISTOR DTC114ES	

Note:
The components identified by mark Δ or dotted line with mark Δ are critical for safety. Replace only with part number specified.

Note:
Les composants identifiés par une marque Δ sont critiques pour la sécurité. Ne les remplacer que par une pièce portant le numéro spécifié.

DISPLAY

TUNER

POWER SUPPLY

TRANSFORMER(2)

Ref.No.	Part No.	Description	Remark
Q006	8-729-202-67	TRANSISTOR 2SK246-GR3	
Q007	8-729-201-84	TRANSISTOR 2SC3112-B	
Q201	8-729-900-61	TRANSISTOR DTA114ES	
Q202	8-729-900-80	TRANSISTOR DTC114ES	
Q240	8-729-900-80	TRANSISTOR DTC114ES	
Q801	8-729-620-05	TRANSISTOR 2SC2603-EF	
Q802	8-729-209-15	TRANSISTOR 2SD2012	
Q803	8-729-119-76	TRANSISTOR 2SA1175-HFE	
Q804	8-729-620-05	TRANSISTOR 2SC2603-EF	
Q805	8-729-119-76	TRANSISTOR 2SA1175-HFE	
Q806	8-729-620-05	TRANSISTOR 2SC2603-EF	
< RESISTOR >			
R001	1-249-411-11	CARBON 330 5%	1/4W
R002	1-249-401-11	CARBON 47 5%	1/4W
R003	1-249-411-11	CARBON 330 5%	1/4W
R004	1-249-415-11	CARBON 680 5%	1/4W
R005	1-249-431-11	CARBON 15K 5%	1/4W
R006	1-249-411-11	CARBON 330 5%	1/4W
R007	1-249-434-11	CARBON 27K 5%	1/4W
R008	1-249-406-11	CARBON 120 5%	1/4W
R016	1-249-431-11	CARBON 15K 5%	1/4W
R017	1-249-423-11	CARBON 3.3K 5%	1/4W
R018	1-249-406-11	CARBON 120 5%	1/4W
R021	1-249-429-11	CARBON 10K 5%	1/4W
R022	1-249-437-11	CARBON 47K 5%	1/4W
R023	1-249-402-11	CARBON 56 5%	1/4W
R024	1-249-430-11	CARBON 12K 5%	1/4W
R025	1-249-421-11	CARBON 2.2K 5%	1/4W
R026	1-249-429-11	CARBON 10K 5%	1/4W
R027	1-249-429-11	CARBON 10K 5%	1/4W
R028	1-249-404-00	CARBON 82 5%	1/4W
R029	1-249-423-11	CARBON 3.3K 5%	1/4W
R032	1-249-438-11	CARBON 56K 5%	1/4W
R033	1-247-881-00	CARBON 120K 5%	1/4W
R034	1-247-883-00	CARBON 150K 5%	1/4W
R035	1-247-881-00	CARBON 120K 5%	1/4W
R036	1-247-883-00	CARBON 150K 5%	1/4W
R037	1-249-423-11	CARBON 3.3K 5%	1/4W
R038	1-249-423-11	CARBON 3.3K 5%	1/4W
R041	1-249-425-11	CARBON 4.7K 5%	1/4W
R042	1-249-425-11	CARBON 4.7K 5%	1/4W
R043	1-249-406-11	CARBON 120 5%	1/4W
R044	1-249-423-11	CARBON 3.3K 5%	1/4W
R045	1-249-414-11	CARBON 560 5%	1/4W
R046	1-249-429-11	CARBON 10K 5%	1/4W
R047	1-249-433-11	CARBON 22K 5%	1/4W
R049	1-249-438-11	CARBON 56K 5%	1/4W

Ref.No.	Part No.	Description	Remark
R051	1-249-417-11	CARBON 1K 5%	1/4W
R052	1-249-417-11	CARBON 1K 5%	1/4W
R053	1-249-417-11	CARBON 1K 5%	1/4W
R055	1-249-417-11	CARBON 1K 5%	1/4W
R056	1-249-405-11	CARBON 100 5%	1/4W
R057	1-249-425-11	CARBON 4.7K 5%	1/4W
R058	1-249-425-11	CARBON 4.7K 5%	1/4W
R059	1-249-421-11	CARBON 2.2K 5%	1/4W
R060	1-249-414-11	CARBON 560 5%	1/4W
R061	1-249-417-11	CARBON 1K 5%	1/4W
R062	1-249-410-11	CARBON 270 5%	1/4W
R063	1-249-425-11	CARBON 4.7K 5%	1/4W
R064	1-249-423-11	CARBON 3.3K 5%	1/4W
R065	1-249-406-11	CARBON 120 5%	1/4W
R066	1-249-417-11	CARBON 1K 5%	1/4W
R067	1-249-429-11	CARBON 10K 5%	1/4W
R068	1-249-429-11	CARBON 10K 5%	1/4W
R069	1-249-429-11	CARBON 10K 5%	1/4W
R071	1-249-429-11	CARBON 10K 5%	1/4W
R201	1-249-433-11	CARBON 22K 5%	1/4W
R202	1-249-429-11	CARBON 10K 5%	1/4W
R203	1-249-437-11	CARBON 47K 5%	1/4W
R204	1-249-433-11	CARBON 22K 5%	1/4W
R205	1-249-411-11	CARBON 330 5%	1/4W
R210	1-249-411-11	CARBON 330 5%	1/4W
R214	1-249-411-11	CARBON 330 5%	1/4W
R216	1-249-404-00	CARBON 82 5%	1/4W
R218	1-249-405-11	CARBON 100 5%	1/4W
R219	1-249-433-11	CARBON 22K 5%	1/4W
R220	1-249-433-11	CARBON 22K 5%	1/4W
R221	1-249-433-11	CARBON 22K 5%	1/4W
R222	1-249-433-11	CARBON 22K 5%	1/4W
R223	1-249-433-11	CARBON 22K 5%	1/4W
R224	1-249-433-11	CARBON 22K 5%	1/4W
R225	1-249-433-11	CARBON 22K 5%	1/4W
R226	1-249-433-11	CARBON 22K 5%	1/4W
R227	△1-249-447-11	CARBON 1 5%	1/4W
R228	△1-249-447-11	CARBON 1 5%	1/4W
R229	1-249-411-11	CARBON 330 5%	1/4W (D3)
R229	1-249-433-11	CARBON 22K 5%	1/4W (D2)
R230	1-249-411-11	CARBON 330 5%	1/4W (D3)
R231	1-249-433-11	CARBON 22K 5%	1/4W
R232	1-249-433-11	CARBON 22K 5%	1/4W
R233	1-249-411-11	CARBON 330 5%	1/4W
R240	1-249-441-11	CARBON 100K 5%	1/4W
R241	1-249-418-11	CARBON 1.2K 5%	1/4W
R242	1-249-433-11	CARBON 22K 5%	1/4W
R243	1-249-438-11	CARBON 56K 5%	1/4W
R244	1-249-437-11	CARBON 47K 5%	1/4W

Note:
The components identified by mark Δ or dotted line with mark Δ are critical for safety. Replace only with part number specified.

Note:
Les composants identifiés par une marque Δ sont critiques pour la sécurité. Ne les remplacer que par une pièce portant le numéro spécifié.

DISPLAY

TUNER

POWER SUPPLY

TRANSFORMER(2)

Ref.No.	Part No.	Description	Remark	Ref.No.	Part No.	Description	Remark
R245	1-249-418-11	CARBON	1. 2K 5% 1/4W	S212	1-554-303-21	SWITCH, TACTILE (SLOPE)	
R246	1-247-887-00	CARBON	220K 5% 1/4W	S213	1-554-303-21	SWITCH, TACTILE ([6])	
R247	1-249-421-11	CARBON	2. 2K 5% 1/4W	S214	1-554-303-21	SWITCH, TACTILE ([7])	
R248	1-249-405-11	CARBON	100 5% 1/4W	S215	1-554-303-21	SWITCH, TACTILE ([-])	
R249	1-249-433-11	CARBON	22K 5% 1/4W	S216	1-554-303-21	SWITCH, TACTILE (ON/OFF)	
R250	1-249-420-11	CARBON	1. 8K 5% 1/4W	S217	1-554-303-21	SWITCH, TACTILE (FREQ/INDEX)	
R290	1-249-441-11	CARBON	100K 5% 1/4W	S218	1-554-303-21	SWITCH, TACTILE (TAPE 1)	
R291	1-249-418-11	CARBON	1. 2K 5% 1/4W	S219	1-554-303-21	SWITCH, TACTILE (BAND)	
R292	1-249-433-11	CARBON	22K 5% 1/4W	S220	1-554-303-21	SWITCH, TACTILE ([5])	
R801	1-249-425-11	CARBON	4. 7K 5% 1/4W	S221	1-554-303-21	SWITCH, TACTILE ([8])	
R802	1-249-396-11	CARBON	18 5% 1/6W	S222	1-554-303-21	SWITCH, TACTILE ([])	
R803	1-249-417-11	CARBON	1K 5% 1/4W	S223	1-554-303-21	SWITCH, TACTILE (MODE)	
R804	1-249-436-11	CARBON	39K 5% 1/4W	S224	1-554-303-21	SWITCH, TACTILE (LEVEL)	
R805	1-249-429-11	CARBON	10K 5% 1/4W	S225	1-554-303-21	SWITCH, TACTILE (DAT)	
R806	1-249-426-11	CARBON	5. 6K 5% 1/4W	S226	1-554-303-21	SWITCH, TACTILE (ON/OFF)	
R807	1-249-429-11	CARBON	10K 5% 1/4W	S227	1-554-303-21	SWITCH, TACTILE ([4])	
R808	1-249-426-11	CARBON	5. 6K 5% 1/4W	S228	1-554-303-21	SWITCH, TACTILE ([9])	
R809	1-249-417-11	CARBON	1K 5% 1/4W	S229	1-554-303-21	SWITCH, TACTILE (PGM)	
R812	1-249-417-11	CARBON	1K 5% 1/4W	S230	1-554-303-21	SWITCH, TACTILE (PRP LOGIC)	
R813	1-249-429-11	CARBON	10K 5% 1/4W	S231	1-554-303-21	SWITCH, TACTILE ([+])	
R901	1-202-725-00	SOLID	3. 3M 10% 1/2W	S232	1-554-303-21	SWITCH, TACTILE (CD)	
		< VARIABLE RESISTOR >		S233	1-554-303-21	SWITCH, TACTILE (D3) (IN/OUT)	
RT001	1-238-601-11	RES, ADJ, CARBON 22K (AM TUNED)		S234	1-554-303-21	SWITCH, TACTILE ([3])	
RT002	1-238-601-11	RES, ADJ, CARBON 22K (AUTO STOP)		S235	1-554-303-21	SWITCH, TACTILE ([0])	
RT003	1-238-602-11	RES, ADJ, CARBON 47K (FM STEREO SEPARATION)		S236	1-554-303-21	SWITCH, TACTILE (RECALL)	
RT004	1-238-604-11	RES, ADJ, CARBON 220K (FM SEP)		S237	1-554-303-21	SWITCH, TACTILE ([<])	
		< VARIABLE RESISTOR >		S238	1-554-303-21	SWITCH, TACTILE (ON/OFF)	
RV240	1-241-563-11	RES, VAR, CARBON 100KX4 (VOLUME)		S239	1-554-303-21	SWITCH, TACTILE (TAPE 2)	
		< RELAY >		S240	1-554-303-21	SWITCH, TACTILE (VIDEO)	
RY901	1-515-701-11	RELAY		S241	1-572-184-11	SWITCH, KEYBOARD (DRLC/POWER)	
		< SWITCH >		S243	1-554-303-21	SWITCH, TACTILE (FM/AM)	
S200	1-554-303-21	SWITCH, TACTILE (POWER)		S244	1-554-303-21	SWITCH, TACTILE ([^])	
S201	1-554-303-21	SWITCH, TACTILE (MEMORY)		S245	1-554-303-21	SWITCH, TACTILE (D3) (CURSOR MODE/TITLE MENU)	
S202	1-554-303-21	SWITCH, TACTILE (TUNER)		S246	1-554-303-21	SWITCH, TACTILE (DIGITAL)	
S203	1-554-303-21	SWITCH, TACTILE ([>])		S247	1-554-303-21	SWITCH, TACTILE (AUDIO)	
S204	1-554-303-21	SWITCH, TACTILE (VIDEO 2/LD)		S248	1-554-303-21	SWITCH, TACTILE (SHIFT)	
S205	1-554-303-21	SWITCH, TACTILE (D3) (ON/OFF)		S249	1-554-303-21	SWITCH, TACTILE ([+])	
S206	1-554-303-21	SWITCH, TACTILE ([2])		S250	1-554-303-21	SWITCH, TACTILE (FM MODE)	
S207	1-554-303-21	SWITCH, TACTILE (USER/PRESET)		S251	1-554-303-21	SWITCH, TACTILE (PHONO)	
S208	1-554-303-21	SWITCH, TACTILE ([+])		S252	1-554-303-21	SWITCH, TACTILE ([^])	
S209	1-554-303-21	SWITCH, TACTILE (RAT)		S253	1-554-303-21	SWITCH, TACTILE (VIDEO 1)	
S210	1-554-303-21	SWITCH, TACTILE (DIRECT)		S254	1-554-303-21	SWITCH, TACTILE (D3) (ON/OFF)	
S211	1-554-303-21	SWITCH, TACTILE (VIDEO 3)		S255	1-554-303-21	SWITCH, TACTILE ([1])	
		< TRANSFORMER >		S256	1-554-303-21	SWITCH, TACTILE ([])	
T001	1-404-743-11	COIL, DISCRIMINATOR					
T002	1-404-742-11	COIL, DISCRIMINATOR					

DISPLAY

TUNER

POWER SUPPLY

TRANSFORMER(2)

DIGITAL (1)

DIGITAL (2)

SURROUND SP

VIDEO

VIDEO (3)

KEY

BALANCE VOLUME

Ref.No.	Part No.	Description	Remark
T901	△1-448-517-21	TRANSFORMER, POWER (D3/D2:US, Canadian)	
T901	△1-448-523-11	TRANSFORMER, POWER (D2:E2, E3)	
		< TERMINAL >	
TM001	* 1-562-907-11	CONNECTOR, F-J (ANTENNA)	
TM002	1-536-707-00	TERMINAL BOARD, PUSH 2P (ANTENNA)	
		< CONNECTOR >	
TP001	* 1-560-060-00	PIN, CONNECTOR 2P (NULL)	
		< VARISTOR >	
VZ901	△1-807-293-11	VARISTOR SNR-14A	
VZ902	△1-807-180-11	VARISTOR SNR-14A300K (D2:E2, E3)	
		< CRYSTAL >	
X001	1-567-826-21	VIBRATOR, CRYSTAL (7.2MHZ)	

	* A-4345-779-A	DIGITAL (1) BOARD, COMPLETE	

	* A-4345-780-A	DIGITAL (2) BOARD, COMPLETE	

	* A-4345-783-A	SURROUND SP TM BOARD, COMPLETE	

	* A-4345-767-A	VIDEO BOARD, COMPLETE (D2)	

	* A-4345-785-A	VIDEO BOARD, COMPLETE (D3)	

	* A-4345-767-A	VIDEO BOARD, COMPLETE (D2)	

	* 1-641-891-11	VIDEO (3) BOARD	

	* 1-641-892-11	KEY BOARD	

	* 1-642-245-11	BALANCE VOLUME BOARD	

		< CAPACITOR >	
C101	1-124-903-11	ELECT	1uF 20% 50V
C102	1-136-165-00	FILM	0.1uF 5% 50V
C103	1-124-903-11	ELECT	1uF 20% 50V
C104	1-136-165-00	FILM	0.1uF 5% 50V
C105	1-124-472-11	ELECT	470uF 20% 10V
C106	1-136-165-00	FILM	0.1uF 5% 50V
C107	1-124-472-11	ELECT	470uF 20% 10V
C108	1-136-165-00	FILM	0.1uF 5% 50V
C109	1-124-903-11	ELECT	1uF 20% 50V
C110	1-124-903-11	ELECT	1uF 20% 50V
C111	1-124-472-11	ELECT	470uF 20% 10V

Ref.No.	Part No.	Description	Remark
C112	1-124-472-11	ELECT	470uF 20% 10V
C113	1-124-903-11	ELECT	1uF 20% 50V
C114	1-164-159-11	CERAMIC	0.1uF 50V
C115	1-164-159-11	CERAMIC	0.1uF 50V
C116	1-124-120-11	ELECT	220uF 20% 25V
C117	1-164-159-11	CERAMIC	0.1uF 50V
C139	1-164-159-11	CERAMIC	0.1uF 50V
C190	1-124-903-11	ELECT	1uF 20% 50V (D3)
C193	1-124-903-11	ELECT	1uF 20% 50V (D3)
C194	1-124-472-11	ELECT	470uF 20% 10V
C195	1-124-903-11	ELECT	1uF 20% 50V (D3)
C301	1-136-153-00	FILM	0.01uF 5% 50V
C302	1-162-306-11	CERAMIC	0.01uF 20% 16V
C303	1-164-159-11	CERAMIC	0.1uF 50V
C304	1-126-096-11	ELECT	10uF 20% 35V
C305	1-126-096-11	ELECT	10uF 20% 35V
C306	1-126-096-11	ELECT	10uF 20% 35V
C307	1-164-159-11	CERAMIC	0.1uF 50V
C308	1-126-163-11	ELECT	4.7uF 20% 50V
C309	1-164-159-11	CERAMIC	0.1uF 50V
C310	1-126-096-11	ELECT	10uF 20% 35V
C311	1-164-159-11	CERAMIC	0.1uF 50V
C312	1-124-598-11	ELECT	22uF 20% 25V
C313	1-164-159-11	CERAMIC	0.1uF 50V
C314	1-124-598-11	ELECT	22uF 20% 25V
C315	1-164-159-11	CERAMIC	0.1uF 50V
C316	1-162-286-31	CERAMIC	220PF 10% 50V
C317	1-162-286-31	CERAMIC	220PF 10% 50V
C318	1-106-347-00	MYLAR	1500PF 5% 200V
C320	1-124-589-11	ELECT	47uF 20% 16V
C321	1-124-589-11	ELECT	47uF 20% 16V
C322	1-124-598-11	ELECT	22uF 20% 25V
C323	1-164-159-11	CERAMIC	0.1uF 50V
C326	1-164-159-11	CERAMIC	0.1uF 50V
C327	1-124-589-11	ELECT	47uF 20% 16V
C328	1-164-159-11	CERAMIC	0.1uF 50V
C329	1-164-159-11	CERAMIC	0.1uF 50V
C330	1-164-159-11	CERAMIC	0.1uF 50V
C331	1-162-207-31	CERAMIC	22PF 5% 50V
C332	1-162-207-31	CERAMIC	22PF 5% 50V
C333	1-106-363-00	MYLAR	6800PF 5% 200V
C334	1-164-159-11	CERAMIC	0.1uF 50V
C335	1-124-589-11	ELECT	47uF 20% 16V
C336	1-164-159-11	CERAMIC	0.1uF 50V
C337	1-164-159-11	CERAMIC	0.1uF 50V
C338	1-162-294-31	CERAMIC	0.001uF 10% 50V

Note:
The components identified by mark △ or dotted line with mark △ are critical for safety. Replace only with part number specified.

Note:
Les composants identifiés par une marque △ sont critiques pour la sécurité. Ne les remplacer que par une pièce portant le numéro spécifié.

DIGITAL (1)

DIGITAL (2)

SURROUND SP

VIDEO

VIDEO (3)

KEY

BALANCE VOLUME

Ref.No.	Part No.	Description	Remark		
-----	-----	-----	-----	-----	-----
C339	1-164-159-11	CERAMIC	0. 1uF		50V
C340	1-126-096-11	ELECT	10uF	20%	35V
C341	1-126-096-11	ELECT	10uF	20%	35V
C342	1-164-159-11	CERAMIC	0. 1uF		50V
C343	1-124-589-11	ELECT	47uF	20%	16V
C344	1-124-589-11	ELECT	47uF	20%	16V
C345	1-124-598-11	ELECT	22uF	20%	25V
C346	1-164-159-11	CERAMIC	0. 1uF		50V
C347	1-164-159-11	CERAMIC	0. 1uF		50V
C348	1-162-290-31	CERAMIC	470PF	10%	50V
C349	1-162-290-31	CERAMIC	470PF	10%	50V
C351	1-136-153-00	FILM	0. 01uF	5%	50V
C352	1-162-306-11	CERAMIC	0. 01uF	20%	16V
C354	1-126-096-11	ELECT	10uF	20%	35V
C355	1-126-096-11	ELECT	10uF	20%	35V
C356	1-126-096-11	ELECT	10uF	20%	35V
C357	1-164-159-11	CERAMIC	0. 1uF		50V
C358	1-126-163-11	ELECT	4. 7uF	20%	50V
C360	1-162-290-31	CERAMIC	470PF	10%	50V
C361	1-162-290-31	CERAMIC	470PF	10%	50V
C362	1-162-290-31	CERAMIC	470PF	10%	50V
C363	1-162-290-31	CERAMIC	470PF	10%	50V
C364	1-162-290-31	CERAMIC	470PF	10%	50V
C365	1-162-290-31	CERAMIC	470PF	10%	50V
C367	1-162-286-31	CERAMIC	220PF	10%	50V
C368	1-106-347-00	MYLAR	1500PF	5%	200V
C369	1-164-159-11	CERAMIC	0. 1uF		50V
C380	1-164-159-11	CERAMIC	0. 1uF		50V
C381	1-124-589-11	ELECT	47uF	20%	16V
C382	1-164-159-11	CERAMIC	0. 1uF		50V
C383	1-124-589-11	ELECT	47uF	20%	16V
C384	1-162-199-31	CERAMIC	10PF	5%	50V
C385	1-162-306-11	CERAMIC	0. 01uF	20%	16V
C386	1-162-211-31	CERAMIC	33PF	5%	50V
C387	1-164-159-11	CERAMIC	0. 1uF		50V
C388	1-162-211-31	CERAMIC	33PF	5%	50V
C389	1-124-589-11	ELECT	47uF	20%	16V
C390	1-124-589-11	ELECT	47uF	20%	16V
C391	1-164-159-11	CERAMIC	0. 1uF		50V
C392	1-124-589-11	ELECT	47uF	20%	16V
C401	1-124-611-00	ELECT	1uF	20%	50V
C402	1-124-589-11	ELECT	47uF	20%	16V
C403	1-164-159-11	CERAMIC	0. 1uF		50V
C404	1-162-205-31	CERAMIC	18PF	5%	50V
C405	1-164-159-11	CERAMIC	0. 1uF		50V
C406	1-162-294-31	CERAMIC	0. 001uF	10%	50V
C407	1-162-294-31	CERAMIC	0. 001uF	10%	50V
C408	1-162-199-31	CERAMIC	10PF	5%	50V
C409	1-124-598-11	ELECT	22uF	20%	25V

Ref.No.	Part No.	Description	Remark		
-----	-----	-----	-----	-----	-----
C410	1-162-211-31	CERAMIC	33PF	5%	50V
C411	1-162-199-31	CERAMIC	10PF	5%	50V
C412	1-164-159-11	CERAMIC	0. 1uF		50V
C413	1-124-589-11	ELECT	47uF	20%	16V
C414	1-164-159-11	CERAMIC	0. 1uF		50V
C415	1-162-294-31	CERAMIC	0. 001uF	10%	50V
C416	1-164-159-11	CERAMIC	0. 1uF		50V
C417	1-164-159-11	CERAMIC	0. 1uF		50V
C418	1-164-159-11	CERAMIC	0. 1uF		50V
C419	1-164-159-11	CERAMIC	0. 1uF		50V
C420	1-124-589-11	ELECT	47uF	20%	16V
C421	1-162-199-31	CERAMIC	10PF	5%	50V
C422	1-164-159-11	CERAMIC	0. 1uF		50V
C423	1-164-159-11	CERAMIC	0. 1uF		50V
C424	1-124-589-11	ELECT	47uF	20%	16V
C425	1-162-294-31	CERAMIC	0. 001uF	10%	50V
C429	1-164-159-11	CERAMIC	0. 1uF		50V
C430	1-124-589-11	ELECT	47uF	20%	16V
C432	1-124-589-11	ELECT	47uF	20%	16V
C501	1-164-159-11	CERAMIC	0. 1uF		50V
C502	1-124-598-11	ELECT	22uF	20%	25V
C503	1-164-159-11	CERAMIC	0. 1uF		50V
C504	1-124-598-11	ELECT	22uF	20%	25V
C505	1-164-159-11	CERAMIC	0. 1uF		50V
C506	1-124-598-11	ELECT	22uF	20%	25V
C507	1-164-159-11	CERAMIC	0. 1uF		50V
C508	1-164-159-11	CERAMIC	0. 1uF		50V
C509	1-124-598-11	ELECT	22uF	20%	25V
C510	1-164-159-11	CERAMIC	0. 1uF		50V
C512	1-164-159-11	CERAMIC	0. 1uF		50V
C513	1-124-598-11	ELECT	22uF	20%	25V
C514	1-164-159-11	CERAMIC	0. 1uF		50V
C515	1-110-340-11	MYLAR	270PF	5%	50V
C516	1-102-106-00	CERAMIC	100PF	10%	50V
C517	1-102-106-00	CERAMIC	100PF	10%	50V
C518	1-102-106-00	CERAMIC	100PF	10%	50V
C519	1-110-341-11	MYLAR	330PF	5%	50V
C520	1-110-341-11	MYLAR	330PF	5%	50V
C521	1-162-215-31	CERAMIC	47PF	5%	50V
C522	1-126-096-11	ELECT	10uF	20%	35V
C523	1-126-096-11	ELECT	10uF	20%	35V
C524	1-124-598-11	ELECT	22uF	20%	25V
C525	1-126-096-11	ELECT	10uF	20%	35V
C526	1-124-589-11	ELECT	47uF	20%	16V
C527	1-164-159-11	CERAMIC	0. 1uF		50V
C528	1-164-159-11	CERAMIC	0. 1uF		50V
C529	1-164-159-11	CERAMIC	0. 1uF		50V
C530	1-124-598-11	ELECT	22uF	20%	25V
C531	1-110-341-11	MYLAR	330PF	5%	50V

DIGITAL (1)

DIGITAL (2)

SURROUND SP

VIDEO

VIDEO (3)

KEY

BALANCE VOLUME

Ref.No.	Part No.	Description		Remark	
C532	1-102-106-00	CERAMIC	100PF	10%	50V
C533	1-130-467-00	MYLAR	470PF	5%	50V
C534	1-102-106-00	CERAMIC	100PF	10%	50V
C535	1-130-467-00	MYLAR	470PF	5%	50V
C536	1-110-341-11	MYLAR	330PF	5%	50V
C539	1-126-096-11	ELECT	10uF	20%	35V
C540	1-126-096-11	ELECT	10uF	20%	35V
C543	1-126-096-11	ELECT	10uF	20%	35V
C547	1-164-159-11	CERAMIC	0.1uF		50V
C548	1-124-589-11	ELECT	47uF	20%	16V
C550	1-124-589-11	ELECT	47uF	20%	16V
C551	1-164-159-11	CERAMIC	0.1uF		50V
C552	1-124-598-11	ELECT	22uF	20%	25V
C553	1-164-159-11	CERAMIC	0.1uF		50V
C554	1-124-598-11	ELECT	22uF	20%	25V
C555	1-164-159-11	CERAMIC	0.1uF		50V
C556	1-124-598-11	ELECT	22uF	20%	25V
C557	1-164-159-11	CERAMIC	0.1uF		50V
C558	1-164-159-11	CERAMIC	0.1uF		50V
C559	1-124-598-11	ELECT	22uF	20%	25V
C560	1-164-159-11	CERAMIC	0.1uF		50V
C562	1-164-159-11	CERAMIC	0.1uF		50V
C563	1-124-598-11	ELECT	22uF	20%	25V
C564	1-164-159-11	CERAMIC	0.1uF		50V
C565	1-110-340-11	MYLAR	270PF	5%	50V
C566	1-102-106-00	CERAMIC	100PF	10%	50V
C567	1-102-106-00	CERAMIC	100PF	10%	50V
C568	1-102-106-00	CERAMIC	100PF	10%	50V
C569	1-110-341-11	MYLAR	330PF	5%	50V
C570	1-110-341-11	MYLAR	330PF	5%	50V
C571	1-162-215-31	CERAMIC	47PF	5%	50V
C572	1-126-096-11	ELECT	10uF	20%	35V
C573	1-126-096-11	ELECT	10uF	20%	35V
C574	1-124-598-11	ELECT	22uF	20%	25V
C575	1-126-096-11	ELECT	10uF	20%	35V
C576	1-124-589-11	ELECT	47uF	20%	16V
C577	1-164-159-11	CERAMIC	0.1uF		50V
C578	1-164-159-11	CERAMIC	0.1uF		50V
C579	1-164-159-11	CERAMIC	0.1uF		50V
C580	1-124-598-11	ELECT	22uF	20%	25V
C581	1-110-341-11	MYLAR	330PF	5%	50V
C582	1-102-106-00	CERAMIC	100PF	10%	50V
C583	1-130-467-00	MYLAR	470PF	5%	50V
C584	1-102-106-00	CERAMIC	100PF	10%	50V
C585	1-130-467-00	MYLAR	470PF	5%	50V
C586	1-110-341-11	MYLAR	330PF	5%	50V
C589	1-126-096-11	ELECT	10uF	20%	35V
C590	1-126-096-11	ELECT	10uF	20%	35V
C593	1-126-096-11	ELECT	10uF	20%	35V

Ref.No.	Part No.	Description		Remark	
C599	1-164-159-11	CERAMIC	0.1uF		50V
C617	1-124-907-11	ELECT	10uF	20%	50V
C621	1-164-159-11	CERAMIC	0.1uF		50V
C623	1-164-159-11	CERAMIC	0.1uF		50V
C635	1-124-907-11	ELECT	10uF	20%	50V
C649	1-124-907-11	ELECT	10uF	20%	50V
C667	1-124-907-11	ELECT	10uF	20%	50V
C685	1-124-907-11	ELECT	10uF	20%	50V
< CONNECTOR >					
CNJ101	* 1-569-588-11	CONNECTOR, DIN (MONITOR/VIDEO 1)			
CNJ102	* 1-569-588-11	CONNECTOR, DIN (VIDEO 1/VIDEO 2)			
CNJ103	* 1-568-826-11	SOCKET, CONNECTOR 7P			
CNJ104	* 1-568-824-11	SOCKET, CONNECTOR 5P (D3)			
CNJ243	* 1-568-850-11	SOCKET, CONNECTOR 7P			
CNJ301	* 1-568-862-11	SOCKET, CONNECTOR 19P			
CNJ302	* 1-563-106-11	CONNECTOR (SOCKET) 10P			
CNJ401	* 1-568-832-11	SOCKET, CONNECTOR 13P			
CNJ501	* 1-568-824-11	SOCKET, CONNECTOR 5P			
CNJ608	* 1-568-830-11	SOCKET, CONNECTOR 11P			
CNJ609	* 1-568-826-11	SOCKET, CONNECTOR 7P			
CNP145	* 1-569-799-11	PLUG, CONNECTOR 5P			
CNP231	* 1-565-295-11	PLUG, CONNECTOR 4P			
CNP301	* 1-564-521-11	PLUG, CONNECTOR 6P			
CNP401	* 1-506-608-11	PIN, CONNECTOR 10P			
CNP501	* 1-564-506-11	PLUG, CONNECTOR 3P			
CNP606	* 1-564-506-11	PLUG, CONNECTOR 3P			
CNP610	* 1-564-506-11	PLUG, CONNECTOR 3P			
CNP611	* 1-564-506-11	PLUG, CONNECTOR 3P			
CNP612	* 1-564-506-11	PLUG, CONNECTOR 3P			
< DIODE >					
D101	8-719-912-20	DIODE 1SS120 (D3)			
D102	8-719-912-20	DIODE 1SS120 (D3)			
D231	8-719-313-72	LED SEL3810A-CD (-20dB)			
D301	8-719-912-20	DIODE 1SS120			
D302	8-719-912-20	DIODE 1SS120			
D303	8-719-903-27	DIODE 1SS168			
D304	8-719-912-20	DIODE 1SS120			
D305	8-719-912-20	DIODE 1SS120			
D306	8-719-912-20	DIODE 1SS120			
D351	8-719-912-20	DIODE 1SS120			
D352	8-719-912-20	DIODE 1SS120			
D401	8-719-912-20	DIODE 1SS120			
D402	8-719-912-20	DIODE 1SS120			
D403	8-719-200-82	DIODE 11ES2			
D404	8-719-918-45	DIODE KV1310			
D405	8-719-903-27	DIODE 1SS168			
D742	8-719-912-20	DIODE 1SS120			

DIGITAL (1)

DIGITAL (2)

SURROUND SP

VIDEO

VIDEO (3)

KEY

BALANCE VOLUME

Ref.No.	Part No.	Description	Remark	Ref.No.	Part No.	Description	Remark
D743	8-719-912-20	DIODE 1SS120		IC553	8-759-711-35	IC NJM4580D	
D744	8-719-912-20	DIODE 1SS120		IC554	8-759-711-35	IC NJM4580D	
D745	8-719-912-20	DIODE 1SS120		IC555	8-759-711-35	IC NJM4580D	
D746	8-719-912-20	DIODE 1SS120		IC556	8-759-711-35	IC NJM4580D	
D747	8-719-912-20	DIODE 1SS120		IC612	8-759-801-01	IC LC4966	
D748	8-719-912-20	DIODE 1SS120		IC614	8-759-711-35	IC NJM4580D	
D749	8-719-912-20	DIODE 1SS120				< JACK >	
		< IC >		J101	1-568-752-51	JACK, PIN (3P SHIELD TYPE) (VIDEO 1/VIDEO 2, LD)	
IC101	8-759-991-77	IC BA7625		J102	1-568-751-51	JACK, PIN (2P SHIELD TYPE) (MONITOR)	
IC102	8-759-991-78	IC BA7626		J138	1-580-174-31	JACK, PIN (3P FRONT) (VIDEO 3)	
IC103	8-759-991-77	IC BA7625		J301	1-568-750-21	JACK, PIN (1P SHIELD TYPE) (COAXIAL)	
IC104	8-759-056-91	IC BA7611AN (D3)		J606	1-573-520-11	JACK, PIN 4P (CENTER/PRE)	
IC301	8-759-999-09	IC CS5326KP-A		J607	1-565-258-11	JACK, PIN 4P (ADAPTOR)	
IC302	8-759-503-91	IC TL082ACP				< COIL >	
IC303	8-759-924-12	IC LM7805CT		L301	1-410-324-11	INDUCTOR 4.7uH	
IC304	8-759-982-21	IC RC78L05A		L302	1-410-397-21	FERRITE BEAD INDUCTOR	
IC305	8-759-982-44	IC RC79L05A		L303	1-410-324-11	INDUCTOR 4.7uH	
IC306	8-759-634-51	IC M5218AP		L304	1-410-324-11	INDUCTOR 4.7uH	
IC307	8-759-148-89	IC uPD6376CX		L305	1-410-324-11	INDUCTOR 4.7uH	
IC308	8-759-822-82	IC CXD2556M		L306	1-410-324-11	INDUCTOR 4.7uH	
IC309	8-750-973-98	IC YM3623B		L307	1-410-324-11	INDUCTOR 4.7uH	
IC310	8-759-916-12	IC SN74HC00AN		L308	1-410-324-11	INDUCTOR 4.7uH	
IC311	8-759-921-08	IC SN74HC02AN		L309	1-410-324-11	INDUCTOR 4.7uH	
IC312	8-759-917-18	IC SN74HCU04AN		L310	1-410-324-11	INDUCTOR 4.7uH	
IC313	8-752-331-87	IC CXD1160AP		L311	1-410-396-41	INDUCTOR 0.45uH	
IC314	8-752-331-87	IC CXD1160AP		L312	1-410-324-11	INDUCTOR 4.7uH	
IC315	8-759-924-12	IC LM7805CT		L313	1-410-499-41	INDUCTOR 1.5uH	
IC316	8-759-978-11	IC MSM3764A-12RS		L401	1-426-850-11	COIL (RF)	
IC317	8-759-917-18	IC SN74HCU04N		L402	1-426-850-11	COIL (RF)	
IC318	8-741-646-01	IC SBX1646-01		L403	1-410-324-11	INDUCTOR 4.7uH	
IC319	8-759-924-12	IC LM7805CT		L405	1-410-324-11	INDUCTOR 4.7uH	
IC400	8-759-982-21	IC RC78L05A		L406	1-410-324-11	INDUCTOR 4.7uH	
IC401	8-759-250-81	IC TC5081AP		L408	1-410-324-11	INDUCTOR 4.7uH	
IC402	8-759-917-11	IC SN74HC393AN		L409	1-410-324-11	INDUCTOR 4.7uH	
IC403	8-759-917-18	IC SN74HCU04AN		L415	1-410-324-11	INDUCTOR 4.7uH	
IC404	8-759-520-53	IC CXD1355AQ		L501	1-410-324-11	INDUCTOR 4.7uH	
IC405	8-759-508-07	IC MS514256-80NC		L551	1-410-324-11	INDUCTOR 4.7uH	
IC406	8-759-520-53	IC CXD1355AQ		L702	* 1-420-872-00	COIL, AIR CORE	
IC407	8-759-508-07	IC MS514256-80NC		L703	* 1-420-872-00	COIL, AIR CORE	
IC408	8-759-917-18	IC SN74HCU04N		L752	* 1-420-872-00	COIL, AIR CORE	
IC409	8-759-982-23	IC RC78L08A				< TRANSISTOR >	
IC501	8-752-335-52	IC CXD2552Q-2		Q101	8-729-119-76	TRANSISTOR 2SA1175-HFE	
IC502	8-759-924-12	IC LM7805CT		Q102	8-729-119-76	TRANSISTOR 2SA1175-HFE	
IC503	8-759-711-35	IC NJM4580D		Q103	8-729-119-76	TRANSISTOR 2SA1175-HFE	
IC504	8-759-711-35	IC NJM4580D		Q104	8-729-119-76	TRANSISTOR 2SA1175-HFE	
IC505	8-759-711-35	IC NJM4580D					
IC506	8-759-711-35	IC NJM4580D					
IC551	8-752-335-52	IC CXD2552Q-2					

DIGITAL (1)

DIGITAL (2)

SURROUND SP

VIDEO

VIDEO (3)

KEY

BALANCE VOLUME

Ref.No.	Part No.	Description	Remark	Ref.No.	Part No.	Description	Remark
Q105	8-729-119-76	TRANSISTOR 2SA1175-HFE		R104	1-247-804-11	CARBON 75 5%	1/4W
Q106	8-729-119-76	TRANSISTOR 2SA1175-HFE		R105	1-247-804-11	CARBON 75 5%	1/4W
Q108	8-729-900-80	TRANSISTOR DTC114ES		R106	1-247-804-11	CARBON 75 5%	1/4W
Q109	8-729-900-80	TRANSISTOR DTC114ES		R107	1-249-429-11	CARBON 10K 5%	1/4W
Q110	8-729-119-76	TRANSISTOR 2SA1175-HFE		R108	1-249-429-11	CARBON 10K 5%	1/4W
Q302	8-729-900-80	TRANSISTOR DTC114ES		R109	1-249-405-11	CARBON 100 5%	1/4W
Q403	8-729-200-56	TRANSISTOR 2SK241-GR		R110	1-249-405-11	CARBON 100 5%	1/4W
Q404	8-729-200-56	TRANSISTOR 2SK241-GR		R111	1-249-413-11	CARBON 470 5%	1/4W
Q405	8-729-900-61	TRANSISTOR DTA114ES		R112	1-249-405-11	CARBON 100 5%	1/4W
Q501	8-729-107-84	TRANSISTOR 2SC3623A-L		R113	1-247-804-11	CARBON 75 5%	1/4W
Q502	8-729-107-84	TRANSISTOR 2SC3623A-L		R114	1-247-804-11	CARBON 75 5%	1/4W
Q503	8-729-107-84	TRANSISTOR 2SC3623A-L		R115	1-249-429-11	CARBON 10K 5%	1/4W
Q504	8-729-107-84	TRANSISTOR 2SC3623A-L		R116	1-249-429-11	CARBON 10K 5%	1/4W
Q506	8-729-107-84	TRANSISTOR 2SC3623A-L		R117	1-249-405-11	CARBON 100 5%	1/4W
Q507	8-729-900-61	TRANSISTOR DTA114ES		R118	1-249-405-11	CARBON 100 5%	1/4W
Q508	8-729-900-61	TRANSISTOR DTA114ES		R119	1-249-413-11	CARBON 470 5%	1/4W
Q509	8-729-900-61	TRANSISTOR DTA114ES		R120	1-249-405-11	CARBON 100 5%	1/4W
Q510	8-729-900-61	TRANSISTOR DTA114ES		R121	1-247-804-11	CARBON 75 5%	1/4W
Q511	8-729-107-84	TRANSISTOR 2SC3623A-L		R122	1-247-804-11	CARBON 75 5%	1/4W
Q512	8-729-107-84	TRANSISTOR 2SC3623A-L		R123	1-247-804-11	CARBON 75 5%	1/4W
Q551	8-729-107-84	TRANSISTOR 2SC3623A-L		R125	1-249-429-11	CARBON 10K 5%	1/4W
Q552	8-729-107-84	TRANSISTOR 2SC3623A-L		R126	1-249-405-11	CARBON 100 5%	1/4W
Q553	8-729-107-84	TRANSISTOR 2SC3623A-L		R127	1-249-405-11	CARBON 100 5%	1/4W
Q554	8-729-107-84	TRANSISTOR 2SC3623A-L		R128	1-249-405-11	CARBON 100 5%	1/4W
Q556	8-729-107-84	TRANSISTOR 2SC3623A-L		R129	1-249-405-11	CARBON 100 5%	1/4W
Q561	8-729-107-84	TRANSISTOR 2SC3623A-L		R137	1-249-433-11	CARBON 22K 5%	1/4W
Q562	8-729-107-84	TRANSISTOR 2SC3623A-L		R139	1-247-804-11	CARBON 75 5%	1/4W
Q604	8-729-900-80	TRANSISTOR DTC114ES		R172	1-247-804-11	CARBON 75 5%	1/4W
Q605	8-729-900-61	TRANSISTOR DTA114ES		R174	1-249-429-11	CARBON 10K 5%	1/4W
Q606	8-729-900-80	TRANSISTOR DTC114ES		R190	1-249-433-11	CARBON 22K 5%	1/4W
Q607	8-729-900-61	TRANSISTOR DTA114ES		R191	1-249-405-11	CARBON 100 5%	1/4W
Q608	8-729-107-84	TRANSISTOR 2SC3623A-L		R192	1-249-425-11	CARBON 4.7K 5%	1/4W (D3)
Q609	8-729-107-84	TRANSISTOR 2SC3623A-L		R193	1-249-425-11	CARBON 4.7K 5%	1/4W (D3)
Q610	8-729-107-84	TRANSISTOR 2SC3623A-L		R194	1-249-425-11	CARBON 4.7K 5%	1/4W (D3)
Q613	8-729-900-61	TRANSISTOR DTA114ES		R195	1-249-425-11	CARBON 4.7K 5%	1/4W (D3)
Q624	8-729-107-84	TRANSISTOR 2SC3623A-L		R196	1-249-433-11	CARBON 22K 5%	1/4W (D3)
Q625	8-729-107-84	TRANSISTOR 2SC3623A-L		R197	1-249-433-11	CARBON 22K 5%	1/4W (D3)
Q626	8-729-107-84	TRANSISTOR 2SC3623A-L		R198	1-247-804-11	CARBON 75 5%	1/4W
Q627	8-729-107-84	TRANSISTOR 2SC3623A-L		R199	1-249-429-11	CARBON 10K 5%	1/4W
Q742	8-729-620-05	TRANSISTOR 2SC2603-EF		R301	1-249-441-11	CARBON 100K 5%	1/4W
Q743	8-729-620-05	TRANSISTOR 2SC2603-EF		R303	1-249-435-11	CARBON 33K 5%	1/4W
Q745	8-729-620-05	TRANSISTOR 2SC2603-EF		R304	1-249-435-11	CARBON 33K 5%	1/4W
Q822	8-729-107-84	TRANSISTOR 2SC3623A-L		R305	1-249-405-11	CARBON 100 5%	1/4W
< RESISTOR >				R306	1-249-401-11	CARBON 47 5%	1/4W
R100	1-249-405-11	CARBON 100 5%	1/4W	R307	1-249-393-11	CARBON 10 5%	1/4W
R101	1-247-804-11	CARBON 75 5%	1/4W	R308	1-249-429-11	CARBON 10K 5%	1/4W
R102	1-247-804-11	CARBON 75 5%	1/4W	R309	1-247-895-00	CARBON 470K 5%	1/4W
R103	1-247-804-11	CARBON 75 5%	1/4W	R310	1-249-426-11	CARBON 5.6K 5%	1/4W
				R311	1-249-405-11	CARBON 100 5%	1/4W

DIGITAL (1)

DIGITAL (2)

SURROUND SP

VIDEO

VIDEO (3)

KEY

BALANCE VOLUME

Ref.No.	Part No.	Description	Remark			Ref.No.	Part No.	Description	Remark		
R312	1-249-405-11	CARBON	100	5%	1/4W	R404	1-249-423-11	CARBON	3.3K	5%	1/4W
R313	1-249-405-11	CARBON	100	5%	1/4W	R405	1-249-413-11	CARBON	470	5%	1/4W
R318	1-249-423-11	CARBON	3.3K	5%	1/4W	R406	1-249-417-11	CARBON	1K	5%	1/4W
R320	1-249-427-11	CARBON	6.8K	5%	1/4W	R407	1-249-429-11	CARBON	10K	5%	1/4W
R321	1-249-420-11	CARBON	1.8K	5%	1/4W	R408	1-249-441-11	CARBON	100K	5%	1/4W
R322	1-249-424-11	CARBON	3.9K	5%	1/4W	R409	1-247-903-00	CARBON	1M	5%	1/4W
R325	1-247-903-00	CARBON	1M	5%	1/4W	R410	1-249-429-11	CARBON	10K	5%	1/4W
R326	1-249-407-11	CARBON	150	5%	1/4W	R411	1-249-428-11	CARBON	8.2K	5%	1/4W
R327	1-249-405-11	CARBON	100	5%	1/4W	R412	1-249-441-11	CARBON	100K	5%	1/4W
R328	1-247-903-00	CARBON	1M	5%	1/4W	R413	1-249-417-11	CARBON	1K	5%	1/4W
R329	1-249-429-11	CARBON	10K	5%	1/4W	R414	1-249-417-11	CARBON	1K	5%	1/4W
R330	1-249-441-11	CARBON	100K	5%	1/4W	R415	1-249-417-11	CARBON	1K	5%	1/4W
R331	1-247-903-00	CARBON	1M	5%	1/4W	R416	1-249-405-11	CARBON	100	5%	1/4W
R332	1-247-804-11	CARBON	75	5%	1/4W	R417	1-249-417-11	CARBON	1K	5%	1/4W
R333	1-249-405-11	CARBON	100	5%	1/4W	R418	1-247-903-00	CARBON	1M	5%	1/4W
R334	1-249-433-11	CARBON	22K	5%	1/4W	R419	1-247-903-00	CARBON	1M	5%	1/4W
R335	1-249-441-11	CARBON	100K	5%	1/4W	R421	1-247-887-00	CARBON	220K	5%	1/4W
R336	1-249-433-11	CARBON	22K	5%	1/4W	R422	1-249-429-11	CARBON	10K	5%	1/4W
R337	1-249-414-11	CARBON	560	5%	1/4W	R423	1-249-429-11	CARBON	10K	5%	1/4W
R338	1-249-414-11	CARBON	560	5%	1/4W	R439	1-249-413-11	CARBON	470	5%	1/4W
R339	1-249-414-11	CARBON	560	5%	1/4W	R440	1-249-413-11	CARBON	470	5%	1/4W
R340	1-249-414-11	CARBON	560	5%	1/4W	R442	1-249-413-11	CARBON	470	5%	1/4W
R341	1-249-414-11	CARBON	560	5%	1/4W	R443	1-249-413-11	CARBON	470	5%	1/4W
R342	1-249-414-11	CARBON	560	5%	1/4W	R444	1-249-413-11	CARBON	470	5%	1/4W
R343	1-249-414-11	CARBON	560	5%	1/4W	R446	1-249-413-11	CARBON	470	5%	1/4W
R344	1-249-414-11	CARBON	560	5%	1/4W	R447	1-249-413-11	CARBON	470	5%	1/4W
R345	1-249-417-11	CARBON	1K	5%	1/4W	R448	1-249-413-11	CARBON	470	5%	1/4W
R346	1-249-417-11	CARBON	1K	5%	1/4W	R449	1-249-417-11	CARBON	1K	5%	1/4W
R347	1-249-417-11	CARBON	1K	5%	1/4W	R450	1-249-417-11	CARBON	1K	5%	1/4W
R348	1-249-417-11	CARBON	1K	5%	1/4W	R451	1-249-417-11	CARBON	1K	5%	1/4W
R349	1-249-417-11	CARBON	1K	5%	1/4W	R452	1-249-417-11	CARBON	1K	5%	1/4W
R350	1-249-417-11	CARBON	1K	5%	1/4W	R453	1-249-417-11	CARBON	1K	5%	1/4W
R351	1-249-441-11	CARBON	100K	5%	1/4W	R454	1-249-417-11	CARBON	1K	5%	1/4W
R352	1-249-417-11	CARBON	1K	5%	1/4W	R455	1-249-417-11	CARBON	1K	5%	1/4W
R353	1-249-435-11	CARBON	33K	5%	1/4W	R456	1-249-417-11	CARBON	1K	5%	1/4W
R354	1-249-435-11	CARBON	33K	5%	1/4W	R491	1-249-433-11	CARBON	22K	5%	1/4W
R355	1-249-405-11	CARBON	100	5%	1/4W	R492	1-249-433-11	CARBON	22K	5%	1/4W
R356	1-249-401-11	CARBON	47	5%	1/4W	R498	1-249-433-11	CARBON	22K	5%	1/4W
R358	1-249-429-11	CARBON	10K	5%	1/4W	R499	1-249-433-11	CARBON	22K	5%	1/4W
R360	1-249-426-11	CARBON	5.6K	5%	1/4W	R500	1-249-425-11	CARBON	4.7K	5%	1/4W
R368	1-249-423-11	CARBON	3.3K	5%	1/4W	R501	1-247-854-11	CARBON	9.1K	5%	1/4W
R370	1-249-427-11	CARBON	6.8K	5%	1/4W	R502	1-249-425-11	CARBON	4.7K	5%	1/4W
R371	1-249-420-11	CARBON	1.8K	5%	1/4W	R503	1-247-854-11	CARBON	9.1K	5%	1/4W
R372	1-249-424-11	CARBON	3.9K	5%	1/4W	R504	1-249-425-11	CARBON	4.7K	5%	1/4W
R380	1-247-903-00	CARBON	1M	5%	1/4W	R505	1-247-862-11	CARBON	20K	5%	1/4W
R381	1-249-401-11	CARBON	47	5%	1/4W	R506	1-249-426-11	CARBON	5.6K	5%	1/4W
R401	1-249-435-11	CARBON	33K	5%	1/4W	R507	1-249-426-11	CARBON	5.6K	5%	1/4W
R402	1-249-437-11	CARBON	47K	5%	1/4W	R508	1-247-862-11	CARBON	20K	5%	1/4W
R403	1-249-423-11	CARBON	3.3K	5%	1/4W	R509	1-249-426-11	CARBON	5.6K	5%	1/4W

DIGITAL (1)

DIGITAL (2)

SURROUND SP

VIDEO

VIDEO (3)

KEY

BALANCE VOLUME

Ref.No.	Part No.	Description			Remark
-----	-----	-----	-----	-----	-----
R510	1-249-426-11	CARBON	5.6K	5%	1/4W
R511	1-249-418-11	CARBON	1.2K	5%	1/4W
R512	1-249-405-11	CARBON	100	5%	1/4W
R513	1-249-423-11	CARBON	3.3K	5%	1/4W
R514	1-249-420-11	CARBON	1.8K	5%	1/4W
R515	1-249-417-11	CARBON	1K	5%	1/4W
R516	1-249-441-11	CARBON	100K	5%	1/4W
R517	1-247-844-11	CARBON	3.6K	5%	1/4W
R518	1-249-425-11	CARBON	4.7K	5%	1/4W
R519	1-249-441-11	CARBON	100K	5%	1/4W
R520	1-249-429-11	CARBON	10K	5%	1/4W
R521	1-249-425-11	CARBON	4.7K	5%	1/4W
R522	1-249-441-11	CARBON	100K	5%	1/4W
R523	1-247-836-11	CARBON	1.6K	5%	1/4W
R524	1-249-421-11	CARBON	2.2K	5%	1/4W
R525	1-247-887-00	CARBON	220K	5%	1/4W
R526	1-249-417-11	CARBON	1K	5%	1/4W
R527	1-249-417-11	CARBON	1K	5%	1/4W
R528	1-249-413-11	CARBON	470	5%	1/4W
R529	1-249-425-11	CARBON	4.7K	5%	1/4W
R530	1-247-854-11	CARBON	9.1K	5%	1/4W
R531	1-249-425-11	CARBON	4.7K	5%	1/4W
R532	1-247-854-11	CARBON	9.1K	5%	1/4W
R533	1-249-425-11	CARBON	4.7K	5%	1/4W
R534	1-247-862-11	CARBON	20K	5%	1/4W
R535	1-249-426-11	CARBON	5.6K	5%	1/4W
R536	1-249-426-11	CARBON	5.6K	5%	1/4W
R537	1-247-862-11	CARBON	20K	5%	1/4W
R538	1-249-426-11	CARBON	5.6K	5%	1/4W
R539	1-249-426-11	CARBON	5.6K	5%	1/4W
R540	1-249-423-11	CARBON	3.3K	5%	1/4W
R541	1-249-433-11	CARBON	22K	5%	1/4W
R542	1-247-887-00	CARBON	220K	5%	1/4W
R543	1-249-425-11	CARBON	4.7K	5%	1/4W
R544	1-249-425-11	CARBON	4.7K	5%	1/4W
R549	1-249-413-11	CARBON	470	5%	1/4W
R550	1-249-425-11	CARBON	4.7K	5%	1/4W
R551	1-247-854-11	CARBON	9.1K	5%	1/4W
R552	1-249-425-11	CARBON	4.7K	5%	1/4W
R553	1-247-854-11	CARBON	9.1K	5%	1/4W
R554	1-249-425-11	CARBON	4.7K	5%	1/4W
R555	1-247-862-11	CARBON	20K	5%	1/4W
R556	1-249-426-11	CARBON	5.6K	5%	1/4W
R557	1-249-426-11	CARBON	5.6K	5%	1/4W
R558	1-247-862-11	CARBON	20K	5%	1/4W
R559	1-249-426-11	CARBON	5.6K	5%	1/4W
R560	1-249-426-11	CARBON	5.6K	5%	1/4W
R561	1-249-418-11	CARBON	1.2K	5%	1/4W
R562	1-249-405-11	CARBON	100	5%	1/4W

Ref.No.	Part No.	Description			Remark
-----	-----	-----	-----	-----	-----
R563	1-249-423-11	CARBON	3.3K	5%	1/4W
R564	1-249-420-11	CARBON	1.8K	5%	1/4W
R565	1-249-417-11	CARBON	1K	5%	1/4W
R566	1-249-441-11	CARBON	100K	5%	1/4W
R567	1-247-844-11	CARBON	3.6K	5%	1/4W
R568	1-249-425-11	CARBON	4.7K	5%	1/4W
R569	1-249-441-11	CARBON	100K	5%	1/4W
R570	1-249-429-11	CARBON	10K	5%	1/4W
R571	1-249-425-11	CARBON	4.7K	5%	1/4W
R572	1-249-441-11	CARBON	100K	5%	1/4W
R573	1-247-836-11	CARBON	1.6K	5%	1/4W
R574	1-249-421-11	CARBON	2.2K	5%	1/4W
R575	1-247-887-00	CARBON	220K	5%	1/4W
R576	1-249-417-11	CARBON	1K	5%	1/4W
R577	1-249-417-11	CARBON	1K	5%	1/4W
R578	1-249-413-11	CARBON	470	5%	1/4W
R579	1-249-425-11	CARBON	4.7K	5%	1/4W
R580	1-247-854-11	CARBON	9.1K	5%	1/4W
R581	1-249-425-11	CARBON	4.7K	5%	1/4W
R582	1-247-854-11	CARBON	9.1K	5%	1/4W
R583	1-249-425-11	CARBON	4.7K	5%	1/4W
R584	1-247-862-11	CARBON	20K	5%	1/4W
R585	1-249-426-11	CARBON	5.6K	5%	1/4W
R586	1-249-426-11	CARBON	5.6K	5%	1/4W
R587	1-247-862-11	CARBON	20K	5%	1/4W
R588	1-249-426-11	CARBON	5.6K	5%	1/4W
R589	1-249-426-11	CARBON	5.6K	5%	1/4W
R590	1-249-423-11	CARBON	3.3K	5%	1/4W
R591	1-249-433-11	CARBON	22K	5%	1/4W
R592	1-247-887-00	CARBON	220K	5%	1/4W
R593	1-249-425-11	CARBON	4.7K	5%	1/4W
R594	1-249-425-11	CARBON	4.7K	5%	1/4W
R595	1-247-903-00	CARBON	1M	5%	1/4W
R596	1-249-441-11	CARBON	100K	5%	1/4W
R597	1-247-903-00	CARBON	1M	5%	1/4W
R598	1-247-903-00	CARBON	1M	5%	1/4W
R599	1-249-413-11	CARBON	470	5%	1/4W
R616	1-249-429-11	CARBON	10K	5%	1/4W
R617	1-249-420-11	CARBON	1.8K	5%	1/4W
R623	1-249-417-11	CARBON	1K	5%	1/4W
R624	1-249-441-11	CARBON	100K	5%	1/4W
R629	1-249-429-11	CARBON	10K	5%	1/4W
R630	1-249-426-11	CARBON	5.6K	5%	1/4W
R632	1-249-433-11	CARBON	22K	5%	1/4W
R633	1-249-413-11	CARBON	470	5%	1/4W
R634	1-249-413-11	CARBON	470	5%	1/4W
R635	1-249-413-11	CARBON	470	5%	1/4W
R636	1-249-426-11	CARBON	5.6K	5%	1/4W
R637	1-249-441-11	CARBON	100K	5%	1/4W

DIGITAL (1)

DIGITAL (2)

SURROUND SP

VIDEO

VIDEO (3)

KEY

BALANCE VOLUME

ON SCREEN

Ref. No.	Part No.	Description	Remark
R638	1-249-426-11	CARBON	5.6K 5% 1/4W
R639	1-249-426-11	CARBON	5.6K 5% 1/4W
R666	1-249-429-11	CARBON	10K 5% 1/4W
R667	1-249-420-11	CARBON	1.8K 5% 1/4W
R673	1-249-417-11	CARBON	1K 5% 1/4W
R676	1-249-433-11	CARBON	22K 5% 1/4W
R677	1-249-433-11	CARBON	22K 5% 1/4W
R739	1-249-417-11	CARBON	1K 5% 1/4W
R740	1-249-429-11	CARBON	10K 5% 1/4W
R749	1-249-389-11	CARBON	4.7 5% 1/4W
R750	1-249-389-11	CARBON	4.7 5% 1/4W
R752	1-249-441-11	CARBON	100K 5% 1/4W
R762	1-249-429-11	CARBON	10K 5% 1/4W
R763	1-249-433-11	CARBON	22K 5% 1/4W
R770	1-249-425-11	CARBON	4.7K 5% 1/4W
R771	1-249-441-11	CARBON	100K 5% 1/4W
R772	1-249-441-11	CARBON	100K 5% 1/4W
R784	1-249-433-11	CARBON	22K 5% 1/4W
R788	1-249-425-11	CARBON	4.7K 5% 1/4W
R789	1-249-417-11	CARBON	1K 5% 1/4W
R790	1-249-429-11	CARBON	10K 5% 1/4W
R799	1-249-389-11	CARBON	4.7 5% 1/4W
R871	1-249-413-11	CARBON	470 5% 1/4W
R873	1-249-413-11	CARBON	470 5% 1/4W
R874	1-249-413-11	CARBON	470 5% 1/4W
R889	1-249-426-11	CARBON	5.6K 5% 1/4W
R891	1-249-426-11	CARBON	5.6K 5% 1/4W
R892	1-249-426-11	CARBON	5.6K 5% 1/4W
R893	1-249-426-11	CARBON	5.6K 5% 1/4W
R894	1-249-426-11	CARBON	5.6K 5% 1/4W
		< VARIABLE RESISTOR >	
RV241	1-238-965-11	RES, VAR, CARBON 100K/100K (BALANCE)	
		< IC >	
RX301	8-749-921-11	IC GP1F32R (OPTICAL)	
		< RELAY >	
RY702	1-515-790-11	RELAY	
RY703	1-515-790-11	RELAY	
RY704	1-515-790-11	RELAY	
		< SWITCH >	
S257	1-572-184-11	SWITCH, KEYBOARD (MUTING)	
S258	1-572-184-11	SWITCH, KEYBOARD (DBFB)	
		< TERMINAL >	
TM702	1-536-706-00	TERMINAL BOARD (SP) (REAR/DRLC SPEAKER)	

Ref. No.	Part No.	Description	Remark
		< CRYSTAL >	
X301	1-577-269-11	VIBRATOR, CRYSTAL (18.432MHz)	
X302	1-579-047-11	VIBRATOR, CRYSTAL (30.798MHz)	

		* A-4345-786-A ON SCREEN BOARD, COMPLETE (D3)	

		< CAPACITOR >	
C119	1-124-907-11	ELECT	10uF 20% 50V
C120	1-164-004-11	CERAMIC CHIP	0.1uF 10% 25V
C121	1-124-907-11	ELECT	10uF 20% 50V
C122	1-163-227-11	CERAMIC CHIP	10PF 5% 50V
C123	1-126-096-11	ELECT	10uF 20% 35V
C124	1-136-162-00	FILM	0.056uF 5% 50V
C125	1-136-153-00	FILM	0.01uF 5% 50V
C126	1-164-004-11	CERAMIC CHIP	0.1uF 10% 25V
C127	1-124-907-11	ELECT	10uF 20% 50V
C128	1-164-004-11	CERAMIC CHIP	0.1uF 10% 25V
C129	1-164-232-11	CERAMIC CHIP	0.01uF 50V
C130	1-163-243-11	CERAMIC CHIP	47PF 5% 50V
C131	1-163-115-00	CERAMIC CHIP	82PF 5% 50V
C132	1-124-907-11	ELECT	10uF 20% 50V
C133	1-124-903-11	ELECT	1uF 20% 50V
C134	1-124-903-11	ELECT	1uF 20% 50V
C135	1-124-903-11	ELECT	1uF 20% 50V
C136	1-124-903-11	ELECT	1uF 20% 50V
C137	1-136-161-00	FILM	0.047uF 5% 50V
C138	1-124-903-11	ELECT	1uF 20% 50V
C140	1-126-096-11	ELECT	10uF 20% 35V
C146	1-130-468-00	MYLAR	560PF 5% 50V
C147	1-124-477-11	ELECT	47uF 20% 25V
C148	1-164-004-11	CERAMIC CHIP	0.1uF 10% 25V
C150	1-124-903-11	ELECT	1uF 20% 50V
C151	1-130-475-00	MYLAR	0.0022uF 5% 50V
C152	1-130-472-00	MYLAR	0.0012uF 5% 50V
C153	1-164-004-11	CERAMIC CHIP	0.1uF 10% 25V
C154	1-124-477-11	ELECT	47uF 20% 25V
C155	1-130-475-00	MYLAR	0.0022uF 5% 50V
C158	1-130-477-00	MYLAR	0.0033uF 5% 50V
C159	1-164-004-11	CERAMIC CHIP	0.1uF 10% 25V
C161	1-130-473-00	MYLAR	0.0015uF 5% 50V
C163	1-164-004-11	CERAMIC CHIP	0.1uF 10% 25V
C164	1-124-477-11	ELECT	47uF 20% 25V
C165	1-164-004-11	CERAMIC CHIP	0.1uF 10% 25V
C168	1-164-004-11	CERAMIC CHIP	0.1uF 10% 25V
C169	1-164-004-11	CERAMIC CHIP	0.1uF 10% 25V

ON SCREEN

Ref.No.	Part No.	Description	Remark	Ref.No.	Part No.	Description	Remark
C170	1-124-477-11	ELECT	47uF 20% 25V	IC130	8-759-925-76	IC SN74HC08ANS	
C171	1-163-234-11	CERAMIC CHIP	20PF 5% 50V	IC171	8-759-902-88	IC SN74LS123NS	
C172	1-163-234-11	CERAMIC CHIP	20PF 5% 50V			< COIL >	
C173	1-164-004-11	CERAMIC CHIP	0.1uF 10% 25V	L101	1-410-470-11	INDUCTOR 10uH	
C174	1-124-477-11	ELECT	47uF 20% 25V	L102	1-410-470-11	INDUCTOR 10uH	
C175	1-164-004-11	CERAMIC CHIP	0.1uF 10% 25V	L103	1-410-470-11	INDUCTOR 10uH	
C181	1-136-165-00	FILM	0.1uF 5% 50V			< TRANSISTOR >	
C182	1-124-925-11	ELECT	2.2uF 20% 100V	Q112	8-729-216-22	TRANSISTOR 2SA1162-G	
C183	1-136-157-00	FILM	0.022uF 5% 50V	Q113	8-729-216-22	TRANSISTOR 2SA1162-G	
C184	1-136-154-00	FILM	0.012uF 5% 50V	Q114	8-729-216-22	TRANSISTOR 2SA1162-G	
C185	1-130-476-00	MYLAR	0.0027uF 5% 50V	Q115	8-729-113-13	TRANSISTOR FA1A4M-L33	
C186	1-124-903-11	ELECT	1uF 20% 50V	Q116	8-729-216-22	TRANSISTOR 2SA1162-G	
C187	1-164-004-11	CERAMIC CHIP	0.1uF 10% 25V	Q117	8-729-113-13	TRANSISTOR FA1A4M-L33	
C188	1-124-477-11	ELECT	47uF 20% 25V	Q118	8-729-113-13	TRANSISTOR FA1A4M-L33	
C197	1-124-477-11	ELECT	47uF 20% 25V	Q119	8-729-113-72	TRANSISTOR FN1A4M-T1M33	
C198	1-164-004-11	CERAMIC CHIP	0.1uF 10% 25V	Q120	8-729-100-66	TRANSISTOR 2SC1623-G	
C199	1-164-004-11	CERAMIC CHIP	0.1uF 10% 25V			< RESISTOR >	
		< CONNECTOR >		R120	1-216-105-00	METAL CHIP 220K 5% 1/10W	
CNJ105 *	1-568-824-11	SOCKET, CONNECTOR 5P		R130	1-216-049-00	METAL CHIP 1K 5% 1/10W	
CNJ106 *	1-568-826-11	SOCKET, CONNECTOR 7P		R131	1-216-059-00	METAL CHIP 2.7K 5% 1/10W	
		< TRIMMER >		R132	1-216-097-00	METAL CHIP 100K 5% 1/10W	
CT101	1-141-227-00	CAP, TRIMMER 20PF		R133	1-216-045-00	METAL CHIP 680 5% 1/10W	
		< IC >		R134	1-216-097-00	METAL CHIP 100K 5% 1/10W	
IC105	8-759-931-47	IC SN74LS628NS		R135	1-216-067-00	METAL CHIP 5.6K 5% 1/10W	
IC106	8-759-636-55	IC M5218AFP		R136	1-216-073-00	METAL CHIP 10K 5% 1/10W	
IC107	8-759-250-81	IC TC5081AP		R137	1-216-073-00	METAL CHIP 10K 5% 1/10W	
IC108	8-759-927-29	IC SN74HCU04ANS		R138	1-216-073-00	METAL CHIP 10K 5% 1/10W	
IC110	8-759-914-57	IC BA7230LS		R140	1-216-039-00	METAL CHIP 390 5% 1/10W	
IC111	8-759-996-03	IC LVA519S		R144	1-216-085-00	METAL CHIP 33K 5% 1/10W	
IC113	8-759-902-88	IC SN74LS123NS		R145	1-216-067-00	METAL CHIP 5.6K 5% 1/10W	
IC114	8-759-907-81	IC SN74LS221NS		R146	1-216-043-00	METAL CHIP 560 5% 1/10W	
IC115	8-759-916-25	IC SN74HC32AN		R147	1-216-051-00	METAL CHIP 1.2K 5% 1/10W	
IC117	8-759-922-51	IC V9938		R150	1-216-065-00	METAL CHIP 4.7K 5% 1/10W	
IC118	8-759-922-42	IC MB81464-12		R151	1-216-041-00	METAL CHIP 470 5% 1/10W	
IC119	8-759-922-42	IC MB81464-12		R152	1-216-063-00	METAL CHIP 3.9K 5% 1/10W	
IC120	8-759-926-80	IC SN74HC573BNS		R153	1-216-059-00	METAL CHIP 2.7K 5% 1/10W	
IC121	8-759-926-77	IC SN74HC541ANS		R154	1-216-065-00	METAL CHIP 4.7K 5% 1/10W	
IC122	8-759-066-22	IC HN27C101AP12-R001		R155	1-216-065-00	METAL CHIP 4.7K 5% 1/10W	
IC123	8-759-927-46	IC SN74HC00ANS		R157	1-216-105-00	METAL CHIP 220K 5% 1/10W	
IC124	8-759-927-46	IC SN74HC00ANS		R158	1-216-072-00	METAL CHIP 9.1K 5% 1/10W	
IC125	8-759-048-99	IC HD6435208F		R159	1-216-059-00	METAL CHIP 2.7K 5% 1/10W	
IC126	8-759-925-82	IC SN74HC21ANS		R160	1-216-083-00	METAL CHIP 27K 5% 1/10W	
IC127	8-759-925-76	IC SN74HC08ANS		R161	1-216-059-00	METAL CHIP 2.7K 5% 1/10W	
IC128	8-759-824-06	IC LC3664RML-12-TE-L		R162	1-216-073-00	METAL CHIP 10K 5% 1/10W	
IC129	8-759-925-78	IC SN74HC10ANS		R163	1-216-073-00	METAL CHIP 10K 5% 1/10W	
				R164	1-216-097-00	METAL CHIP 100K 5% 1/10W	

ON SCREEN

Ref. No.	Part No.	Description	Remark
R165	1-216-063-00	METAL CHIP	3.9K 5% 1/10W
R166	1-216-049-00	METAL CHIP	1K 5% 1/10W
R167	1-216-049-00	METAL CHIP	1K 5% 1/10W
R168	1-216-041-00	METAL CHIP	470 5% 1/10W
R169	1-216-085-00	METAL CHIP	33K 5% 1/10W
R171	1-216-073-00	METAL CHIP	10K 5% 1/10W
R173	1-216-073-00	METAL CHIP	10K 5% 1/10W
R177	1-216-748-11	METAL CHIP	39K 1% 1/10W
R178	1-216-093-00	METAL CHIP	68K 5% 1/10W
R179	1-216-064-00	METAL CHIP	4.3K 5% 1/10W
R180	1-216-041-00	METAL CHIP	470 5% 1/10W
R181	1-216-041-00	METAL CHIP	470 5% 1/10W
R182	1-216-067-00	METAL CHIP	5.6K 5% 1/10W
R183	1-216-055-00	METAL CHIP	1.8K 5% 1/10W
R184	1-216-069-00	METAL CHIP	6.8K 5% 1/10W
R185	1-216-057-00	METAL CHIP	2.2K 5% 1/10W
R186	1-216-063-00	METAL CHIP	3.9K 5% 1/10W
R187	1-216-057-00	METAL CHIP	2.2K 5% 1/10W
R188	1-216-057-00	METAL CHIP	2.2K 5% 1/10W
R189	1-216-057-00	METAL CHIP	2.2K 5% 1/10W
R1001	1-216-081-00	METAL CHIP	22K 5% 1/10W
R1002	1-216-073-00	METAL CHIP	10K 5% 1/10W
R1003	1-216-073-00	METAL CHIP	10K 5% 1/10W
< VARIABLE RESISTOR >			
RV103	1-238-991-00	RES, ADJ, METAL 2.2K	
RV104	1-238-600-11	RES, ADJ, CARBON 10K	
RV105	1-238-597-11	RES, ADJ, CARBON 1K	
RV106	1-238-598-11	RES, ADJ, CARBON 2.2K	
< THERMISTOR >			
THP101	1-806-366-11	THERMISTOR (POSITIVE)	
< CONNECTOR >			
TP101	* 1-560-060-00	PIN, CONNECTOR 2P	
TP102	* 1-560-060-00	PIN, CONNECTOR 2P	
TP103	* 1-560-060-00	PIN, CONNECTOR 2P	
< CRYSTAL >			
X102	1-567-505-11	OSCILLATOR, CRYSTAL	
X103	1-577-121-11	VIBRATOR, CRYSTAL	

MISCELLANEOUS			

13	1-575-968-11	WIRE, FLAT TYPE (7 CORE)	
17	1-690-091-11	WIRE, FLAT TYPE (21 CORE)	

Ref. No.	Part No.	Description	Remark
61	1-590-031-11	WIRE, FLAT TYPE (5 CORE)	
62	1-590-240-11	WIRE, FLAT TYPE (7 CORE)	
69	1-590-036-11	WIRE, FLAT TYPE (13 CORE)	
70	* 1-590-241-11	WIRE, FLAT TYPE (11 CORE)	
71	1-690-421-11	WIRE, FLAT TYPE (7 CORE)	
72	1-690-420-21	WIRE, FLAT TYPE (7 CORE)	
73	1-690-422-11	WIRE, FLAT TYPE (19 CORE)	
74	1-690-635-11	WIRE, FLAT TYPE (7 CORE)	
76	1-535-706-11	PLUG, JUMPER	
77	1-534-517-00	WIRE, FLAT TYPE (11 CORE)	
110	△1-575-975-11	CORD, POWER (D3/D2:US, Canadian)	
110	△1-590-074-11	CORD, POWER (D2:E2, E3)	
111	△1-569-007-11	ADAPTER, CONVERSION 2P (D2:E2/E3)	
D721	8-719-302-37	DIODE RBV-602	
F601	△1-576-109-11	FUSE T5A	
F602	△1-576-109-11	FUSE T5A	
F603	△1-576-108-11	FUSE T4A	
F901	△1-532-350-00	FUSE, TIME-LAG (D2:E2/E3) T4A	
F901	△1-576-108-11	FUSE (D2/D3:US, Canadian) T4A	
F902	△1-532-749-11	FUSE, GLASS TUBE (D3/D2:US, Canadian) T8A	
F903	△1-532-350-00	FUSE, TIME-LAG (D2:E2/E3) T4A	
F904	△1-532-350-00	FUSE, TIME-LAG (D2:E2/E3) T4A	
F905	△1-532-350-00	FUSE, TIME-LAG (D2:E2/E3) T4A	
Q702	8-729-320-82	TRANSISTOR 2SC2922-0Y	
Q705	8-729-209-15	TRANSISTOR 2SD2012	
Q709	8-729-320-74	TRANSISTOR 2SA1216-0Y	
Q752	8-729-320-82	TRANSISTOR 2SC2922-0Y	
Q755	8-729-209-15	TRANSISTOR 2SD2012	
Q759	8-729-320-74	TRANSISTOR 2SA1216-0Y	
T902	△1-450-692-11	TRANSFORMER, POWER (D3/D2:US, Canadian)	
T902	△1-450-780-11	TRANSFORMER, POWER (D2:E2/E3)	

ACCESSORIES & PACKING MATERIALS			

1-417-141-11 MATCHING TRANSFORMER, ANTENNA			
1-465-810-11 COMMANDER, STANDARD (RM-P311)			
1-501-224-00 ANTENNA, FEEDER			
1-501-374-11 ANTENNA, LOOP			
3-754-061-21 MANUAL, INSTRUCTION(ENGLISH)			
3-754-061-31 MANUAL, INSTRUCTION(FRENCH)			
(D3/D2:Canadian)			
3-795-433-31 INSTRUCTION (D3/D2:Canadian)			
4-925-079-01 COVER (6), BATTERY			
* 4-931-047-01 CUSHION			
* 4-949-403-01 INDIVIDUAL CARTON (D2)			
* 4-949-404-01 INDIVIDUAL CARTON (D3)			
9-910-999-33 INSTRUCTION (D2:US)			

Note:
The components identified by mark Δ or dotted line with mark Δ are critical for safety. Replace only with part number specified.

Note:
Les composants identifiés par une marque Δ sont critiques pour la sécurité. Ne les remplacer que par une pièce portant le numéro spécifié.

Ref.No.	Part No.	Description	Remark
---------	----------	-------------	--------

HARDWARE LIST

#1	7-682-548-09	SCREW +BVTT 3X8 (S)	
#2	7-682-547-04	SCREW +BVTT 3X6 (S)	
#3	7-682-548-04	SCREW +BVTT 3X8 (S)	
#4	7-685-647-79	SCREW +BVTP 3X10 TYPE2 N-S	
#5	7-682-550-09	SCREW +B 3X12	
#6	7-682-547-09	SCREW +BVTT 3X6 (S)	
#7	7-682-561-04	SCREW +BVTT 4X8 (S)	
#8	7-685-646-79	SCREW +BTP 3X8 TYPE2 N-S	

STR-D2070X / D3070X

SONY[®] SERVICE MANUAL

US Model
Canadian Model

STR-D2070X/D3070X:

E Model

STR-D2070X:





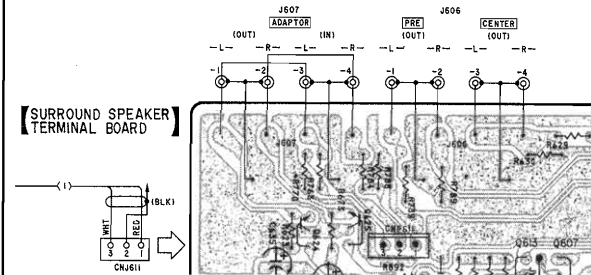
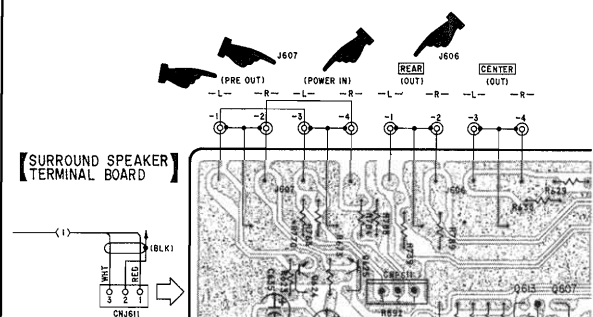

CORRECTION-1

Correct your service manual as shown below.

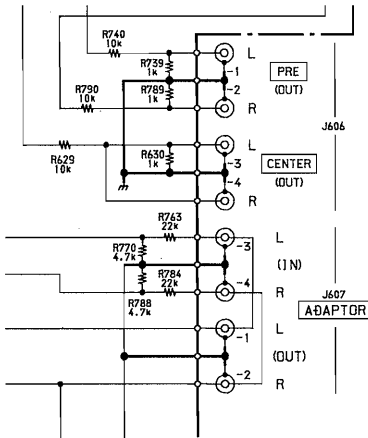
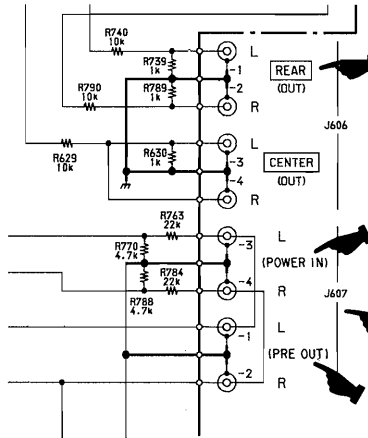
 : indicates corrected portion.

Page	INCORRECT	CORRECT																				
1	<table border="1"> <tr> <td rowspan="4">Input sensitivity/ impedance</td> <td>PHONO MM</td> <td>2.5 mV, 50 kilohms</td> </tr> <tr> <td>DAT, CD, VIDEO 1,2,3 TAPE 1, 2</td> <td>150 mV 50 kilohms</td> </tr> <tr> <td>DIGITAL (COAXIAL)</td> <td>0.5Vp-p, ± 20%, 75 ohms</td> </tr> <tr> <td>DIGITAL (OPTICAL)</td> <td>TOSLINK</td> </tr> </table>	Input sensitivity/ impedance	PHONO MM	2.5 mV, 50 kilohms	DAT, CD, VIDEO 1,2,3 TAPE 1, 2	150 mV 50 kilohms	DIGITAL (COAXIAL)	0.5Vp-p, ± 20%, 75 ohms	DIGITAL (OPTICAL)	TOSLINK	<table border="1"> <tr> <td rowspan="5">Input sensitivity/ impedance</td> <td>PHONO MM</td> <td>2.5 mV, 50 kilohms</td> </tr> <tr> <td>DAT, CD, VIDEO 1,2,3 TAPE 1, 2</td> <td>150 mV 50 kilohms</td> </tr> <tr> <td>DIGITAL (COAXIAL)</td> <td>0.5Vp-p, ± 20%, 75 ohms</td> </tr> <tr> <td>DIGITAL (OPTICAL)</td> <td>TOSLINK</td> </tr> <tr> <td>POWER IN</td> <td>1V</td> </tr> </table>	Input sensitivity/ impedance	PHONO MM	2.5 mV, 50 kilohms	DAT, CD, VIDEO 1,2,3 TAPE 1, 2	150 mV 50 kilohms	DIGITAL (COAXIAL)	0.5Vp-p, ± 20%, 75 ohms	DIGITAL (OPTICAL)	TOSLINK	POWER IN	1V
Input sensitivity/ impedance	PHONO MM		2.5 mV, 50 kilohms																			
	DAT, CD, VIDEO 1,2,3 TAPE 1, 2		150 mV 50 kilohms																			
	DIGITAL (COAXIAL)		0.5Vp-p, ± 20%, 75 ohms																			
	DIGITAL (OPTICAL)	TOSLINK																				
Input sensitivity/ impedance	PHONO MM	2.5 mV, 50 kilohms																				
	DAT, CD, VIDEO 1,2,3 TAPE 1, 2	150 mV 50 kilohms																				
	DIGITAL (COAXIAL)	0.5Vp-p, ± 20%, 75 ohms																				
	DIGITAL (OPTICAL)	TOSLINK																				
	POWER IN	1V																				
21	 <p>Diagram showing the surround speaker terminal board (CN4611) with connections for J607 (ADAPTOR), J606 (PRE OUT), and J608 (CENTER OUT). The diagram shows incorrect wiring for the PRE OUT and CENTER OUT sections.</p>	 <p>Diagram showing the surround speaker terminal board (CN4611) with connections for J607 (ADAPTOR), J606 (PRE OUT), and J608 (CENTER OUT). The diagram shows corrected wiring for the PRE OUT and CENTER OUT sections, with arrows indicating the corrected portions.</p>																				

 : indicates corrected portion

Page	INCORRECT	CORRECT																								
37																										
75	<table border="1"> <thead> <tr> <th>Ref. No.</th> <th>Part No.</th> <th>Description</th> <th>Remark</th> </tr> </thead> <tbody> <tr> <td>J606</td> <td>1-573-520-11</td> <td>JACK, PIN 4P (CENTER/PRE)</td> <td></td> </tr> <tr> <td>J607</td> <td>1-565-258-11</td> <td>JACK, PIN 4P (ADAPTOR)</td> <td></td> </tr> </tbody> </table>	Ref. No.	Part No.	Description	Remark	J606	1-573-520-11	JACK, PIN 4P (CENTER/PRE)		J607	1-565-258-11	JACK, PIN 4P (ADAPTOR)		<table border="1"> <thead> <tr> <th>Ref. No.</th> <th>Part No.</th> <th>Description</th> <th>Remark</th> </tr> </thead> <tbody> <tr> <td>J606</td> <td>1-573-520-11</td> <td>JACK, PIN 4P (CENTER/REAR)</td> <td></td> </tr> <tr> <td>J607</td> <td>1-565-258-11</td> <td>JACK, PIN 4P (PRE OUT/POWER IN)</td> <td></td> </tr> </tbody> </table>	Ref. No.	Part No.	Description	Remark	J606	1-573-520-11	JACK, PIN 4P (CENTER/REAR)		J607	1-565-258-11	JACK, PIN 4P (PRE OUT/POWER IN)	
Ref. No.	Part No.	Description	Remark																							
J606	1-573-520-11	JACK, PIN 4P (CENTER/PRE)																								
J607	1-565-258-11	JACK, PIN 4P (ADAPTOR)																								
Ref. No.	Part No.	Description	Remark																							
J606	1-573-520-11	JACK, PIN 4P (CENTER/REAR)																								
J607	1-565-258-11	JACK, PIN 4P (PRE OUT/POWER IN)	